

No. RW/NH-15017/46/2018-P&M  
Government of India  
Ministry of Road Transport & Highways  
(P&M Section)  
Transport Bhawan, No.1, Parliament Street, New Delhi-110001.

Dated 29<sup>th</sup> April, 2022

To,

1. The Chief Secretaries of all the State Governments/ UTs
2. The Principal Secretaries/ Secretaries of all States/ UTs Public Works Department/ Road Construction Department/ Highway Departments (dealing with National Highways, State Roads and Roads under Centrally Sponsored Schemes)
3. The Chairman, National Highways Authority of India, G-5 & 6, Sector-10, Dwarka, New Delhi-110075
4. The Managing Director, NHIDCL, PTI Building, New Delhi-110001
5. The Director General (Border Road), Seema Sadak Bhawan, Ring Road, New Delhi-110010
6. All Engineers-in-Chief and Chief Engineers of Public Works Department of States/ UTs/ Road Construction Department/ Highway Departments (dealing with National Highways).
7. All Engineers-in-Chief and Chief Engineers of Public Works Department of States/ UTs/ Road Construction Department/ Highway Departments (dealing with State Roads and Roads under Centrally Sponsored Schemes).

**Sub:** - Road Over Bridges (ROBs) - Compendium for ROBs on Indian Railways (Report BS-132) - Reg.

**Ref:** - Compendium for Road Over Bridges on Indian Railways (Report BS-132) of Research Designs and Standards Organisation.

Sir/ Madam,

The undersigned is directed to refer to the Compendium for Road Over Bridges (ROBs) on Indian Railways (Report BS-132) issued by Research Designs and Standards Organisation (RDSO). The main objectives of this Compendium is as follows: -

- (i) Disseminate good practices in planning of ROBs, launching operations and create a repository of drawings in use over Indian Railways.
- (ii) Save precious time and avoid the duplicity of efforts in developing designs for each ROB.
- (iii) RDSO has standardized ROB girder designs for various span configurations such as RDSO standard as well as non RDSO drawings, which are to be adopted for Railway portion spans.

2. Copy of the "Compendium for Road Over Bridges on Indian Railways (Report BS-132)" issued by RDSO is enclosed herewith for ready reference.



3. It is requested that all Executing Agencies, States/ UTs may use the "Compendium for Road Over Bridges on Indian Railways (Report BS-132)" issued by RDSO, for construction of ROB on National Highways, under other Central Sector Schemes and on State Roads (taken-up under CRIF scheme).

4. This issues with the approval of Secretary (RT&H).

Encl.: As above

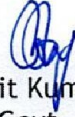

(Ranajit Kumar Roy)  
Under Secretary to the Govt. of India  
Ph: 011-23321729  
Email:planningmorth@gmail.com

Copy for information and necessary action to:-

1. All ADGs/ CEs/ JSs in the Ministry.
2. All ROs of Ministry - It is requested to convey this letter to concerned State Govts./UTs.
3. SE[S&R(B)]

Copy for information and necessary action to:-

1. PS to Hon'ble Minister (RT&H)
2. PS to Hon'ble MOS (RT&H)
3. Sr. PPS to Secretary (RT&H)
4. Sr. PPS to DG(RD)&SS
5. Sr. PPS to AS&FA/ Additional Secretary (RT&H)
6. NIC, MoRT&H - Requested to upload in Ministry's website under "What's New"
7. Secretary (General), IRC
8. Director, IAHE





Government of India  
Ministry of Railways



अभियांत्रिकी RDSO  
रेल अग्रदूत Transforming Railways  
www.rdsco.indianrailways.gov.in

**COMPENDIUM FOR  
ROAD OVER BRIDGES  
ON INDIAN RAILWAYS  
(REPORT BS-132)**

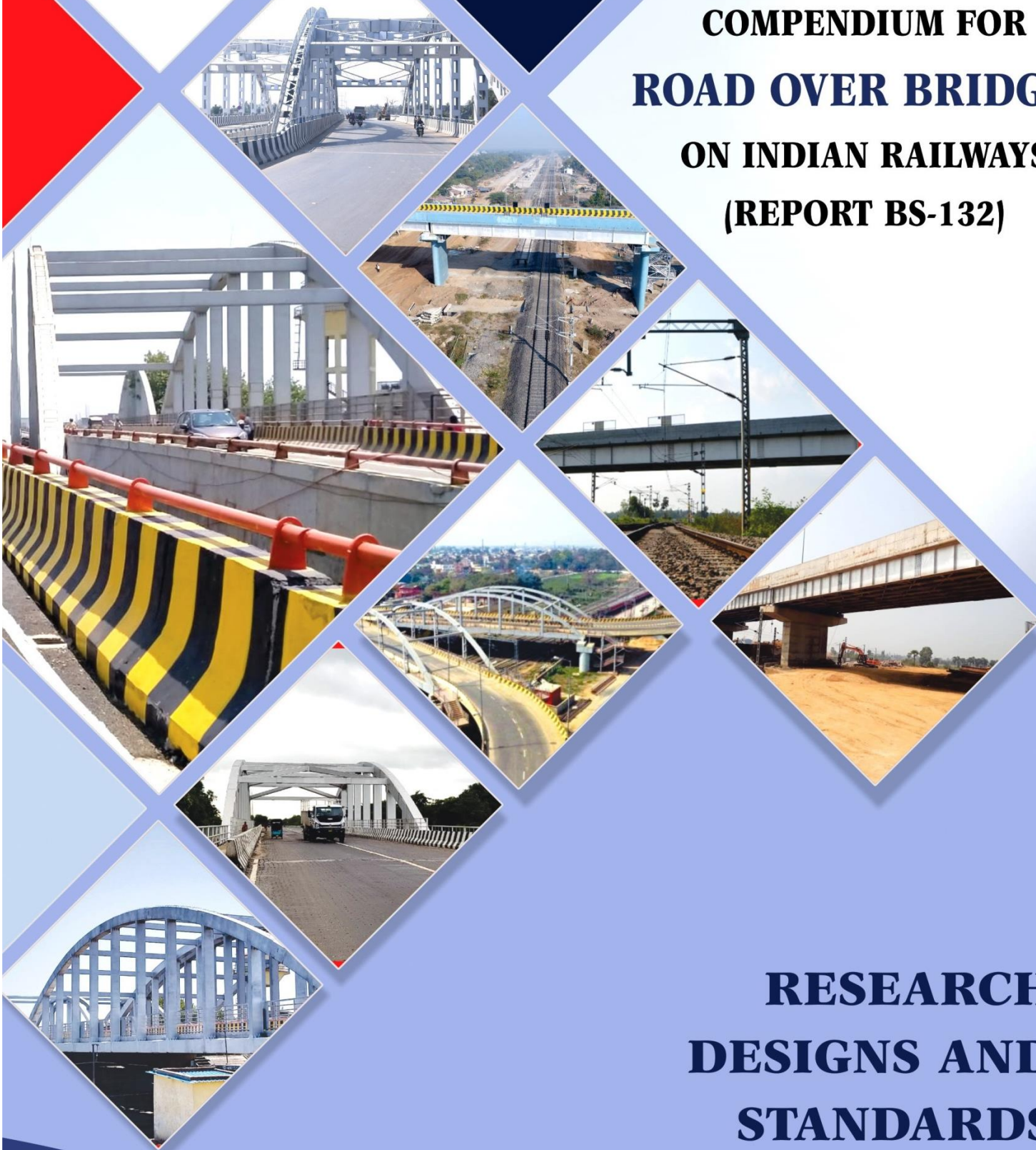

**RESEARCH  
DESIGNS AND  
STANDARDS  
ORGANISATION**

**BACK OF COVER PAGE**  
**(BLANK)**





## **FOREWORD**

Road Over Bridges (ROBs) are key components of any Road network. Ambitious expansion of road network in the Country requires construction of ROBs on a large scale. Indian Railways has also embarked on a mission to eliminate manned level crossings to improve mobility and safety in train operations. Thus, fast track and cost-effective construction of ROBs across the Indian Railway network is need of the hour.

The above objectives can be achieved only through meticulous planning and adoption of cost effective design and construction methodologies. In a step forward, RDSO has prepared this Compendium for Road Over Bridges on Indian Railways with an aim to disseminate good practices in planning of ROBs, launching operations and to create a repository of drawings in use over Indian Railways. It will not only save precious time but also avoid the duplicity of efforts in developing designs for each ROB. The fact that 188 drawings included in the Compendium have been approved by Zonal Railways should obviate the need for approval if they are to be used. Apart from this, 30 RDSO standard drawings have also been included in this Compendium. All these drawings are to be adopted for Railway portion spans only.

The Compendium is being issued in the form of RDSO Report No. BS-132 for use over Indian Railways. It is hoped that Zonal railways, NHAI, State Governments, etc. will get benefitted from the Compendium for expeditious execution of ROB Projects.

**Bridge & Structures Directorate**  
**RDSO-Lucknow**

This page is left blank intentionally.



## CONTENTS

Sl. No.	Description		Page No.
1	Foreword		i
2	Contents		ii
3	<b>Chapter I</b>	Introduction	1-6
4	<b>Chapter II</b>	Planning of Road Over Bridges (ROBs)	7-24
5	<b>Chapter III</b>	List of Drawings suitable for Special Vehicle Loading	25-80
6	<b>Chapter IV</b>	List of drawings for other than Special Vehicle Loading	81-130
7	<b>Chapter V</b>	Instructions regarding approval of non-RDSO drawings	131-134
8	<b>Chapter VI</b>	Summary of technical publications issued by RDSO for execution of ROBs	135-142
9	<b>Chapter VII</b>	Instructions regarding launching of girders	143-166
10	<b>Annexures</b>	1- Railway Board's instruction regarding layout of piers and selection of span for ROBs. 2- Railway Board's instruction regarding Skew angles to be adopted in the Road Over Bridges (ROBs).	167-171

---

*While every care has been taken to ensure accurate compilation, users are advised to refer to original drawings, latest letters and instructions on these technical matters. The Compendium is a referral document and should not be a basis for deciding contractual & financial matters. Nothing in this Compendium supersedes any instructions on the subject matter issued by Railway Board, RDSO and IRC. Examples and illustrations contained in the Compendium are indicative only. Please give feedback to RDSO if there are any issues/ errors with respect to these designs/drawings.*

**Chapter I**  
**Introduction**

This page is left blank intentionally.



- 1.1 Level crossings (LCs) over Indian Railways network have always remained a safety concern for road users as well as railway passengers. All unmanned level crossings have been successfully eliminated from Indian Railways network in a mission mode. However, on manned level crossings, Road Over Bridges (ROBs) in lieu of these level crossings are generally constructed, if traffic density is more than one lakh Train Vehicle Units (TVUs) subject to consent of State Government for closure of the LC and sharing of cost.
- 1.2 Proposals for construction of ROBs in lieu of level crossings are received at various levels in Zonal Railways from State Government/ Road Authorities. After completing various formalities these works are sanctioned, normally on cost sharing basis.
- 1.3 Faster execution of these ROB works not only increases safety of Road and Railway Passengers but also reduces disruption to train operations. It is important that time taken in planning, designing and execution of ROB works is reduced to the maximum possible extent. In order to achieve this objective, RDSO has standardized ROB girder designs for various span configurations. This standardization has helped field Engineers a lot in adopting standard spans for repetitive use instead of wastage of time and money spent in designing these girders for each use case.
- 1.4 Railway Board has issued instructions time and again to adopt standard design of ROB girders issued by RDSO for ROBs from safety consideration as-well-as to expedite execution of work. However in unavoidable circumstances non-RDSO spans can be used due to site constraints. Many such non-standard ROB spans have been designed and used by various Zonal Railways. This compendium is an effort to compile all such RDSO standard as-well-as non RDSO drawings and make them available for all stake holders involved in ROB planning and execution works. These drawings are to be adopted for Railway portion spans only.

1.5 Typically, ROB girders can be classified into following types:

- a) Bow String Arch Steel Girders,
- b) Composite Steel Plate Girders,
- c) Truss type (Open Web) Steel Girders,
- d) Pre-stressed Concrete (PSC) I-section Girders,
- e) Pre-stressed Concrete (PSC) Box Girders.
- f) Pre-stressed Concrete (PSC) Segmented Box Girder



Fig. a): Composite Steel Plate Girder



Fig. b): Truss type (Open Web) Steel Girder



Fig. c): Bow String Arch Steel Girder

**Figure 1:** Types of ROB Girders

1.6 For developing design and drawings following Codes and Special Publications are helpful-

IRC SP:73-2018	Manual of Specifications and Standards for Two Laning of Highways with Paved Shoulder.
IRC SP:84-2019	Manual of Specifications and Standards for Four Laning of Highways.
IRC SP:87-2019	Manual of Specifications and Standards for Six Laning of Highways.
IRC 5-2015	Standard Specifications and Code Of Practice for Road Bridges, Section -I General Features of Design.
IRC 6-2017	Standard Specifications and Code of Practice for Road Bridges, Section-II – Loads and Stresses
IS 800-2007	General Construction in Steel — Code of Practice.
IRC SP:69-2011	Guidelines and Specifications for Expansion Joints.
IRC 22-2015	Standard Specifications and Code of Practice for Road Bridges, Section-VI – Composite Construction.
IRC 24-2010	Standard Specifications and Code of Practice for Road Bridges, Section-V – Steel Road Bridges.
IRC 83	Standard Specifications and Code of Practice for Road Bridges, Bearings.
IRC 112-2020	Code of Practice for Concrete Road Bridges.
IS 2062-2011	Hot Rolled Medium and High Tensile Structural Steel – Specification.
IS 816-1969	Code of Practice for use of Metal Arc Welding for General Construction in Mild Steel.
IS 1786-2008	High Strength Deformed Steel Bars and Wires for Concrete Reinforcement – Specification.

IS 9595-1996	Metal-Arch Welding of Carbon and Carbon Manganese Steel – Recommendations.
IRC:78 - IRC 78-2014	Road Bridges Foundation and Substructure
IRC SP:105	Explanatory Handbook to IRC:112 Code of Practice for Concrete Road Bridges
IS 2911 -	Design and Construction of Pile Foundations -Code of Practice (all parts)

Note: Readers are advised to always refer latest version of Code/Specification for making references.

- 1.7 For guidance of field engineers involved in Steel Girder Fabrication, RDSO has published many Technical Guidelines covering structural as-well-as Quality Control related aspects. Chapter VI contains a list of these Technical Publications along with brief description of the contents therein. A thorough understanding of these aspects will result in quality manufacturing of steel girders.



## **Chapter II**

### **Planning of Road Over Bridges (ROBs)**

This page is left blank intentionally.

## **2.1 Planning of Road Over Bridges (ROBs): General**

2.1.1 Road Over Bridges are being planned at a large number of places on Indian Railways to eliminate the level crossings. These assets are going to be over the railway system for a long time and proper planning of these will not only ensure proper facility to the road users but also reduce problems to railway operations/ maintenance in future. As far as possible it is recommended to use RDSO standard drawings to avoid the time and cost involved in development of design and drawings repeatedly.

2.1.2 Railway Board has also issued instructions regarding this, time and again. Still there are site conditions where it is not possible to always adopt RDSO standard span for a ROB. In such situations thorough understanding of ROB planning is necessary to plan a suitable girder for that case especially in cases of skew crossings. The following content will help in understanding these planning aspects which are necessary for Engineers and Executives involved in ROB planning and construction.

## **2.2 Planning Layout of piers and planning span lengths:**

2.2.1 Deciding the layout of piers and planning of span lengths is one of the most important exercises for any ROB construction. Railway desires that the pier/ abutment should be located just outside or at the railway boundaries to the extent possible. But in doing so, the span length may sometimes become too high resulting into higher depth of girders and more expenditure. Road Authorities may not agree to this kind of arrangement. Under these circumstances it becomes difficult to decide the matter.

2.2.2 The matter was well deliberated in the Railway Board and clear instructions had been issued regarding this. The same is being reproduced for the ready reference as Annexure – I of this Compendium.

**2.3 Planning of foundations:** Deep foundations are, in general, costlier as compared to the open foundations. The ROBs don't have water flowing around them, so scour is not a concern and the depth of foundation can be kept smaller also. If the soil conditions dictate or there is some other advantages like ease of construction, reduction in duration of speed restriction, we may go in for deep foundations like piles. If such constraints are not there open foundations shall be adopted, if feasible from bearing capacity considerations.

**2.4 Planning of sub structure:** Normal construction methodology followed in majority of ROBs involves providing RCC sub structure in the ROBs. At locations where space available is less, lots of extra care is required at site during concrete casting to ensure safety of train operations. This problem can be tackled by imposing suitable speed restrictions and/or working in blocks. At such locations, it would, therefore, be worth considering the option of providing precast concrete or steel sub structure. Steel sub structure can be clad in precast concrete to give it a better look. It can expedite the pace of construction. Innovative methods can be explored around these methods in order to save the construction time as well as time of imposition of Speed Restriction.

**2.5 Planning of girders:**

2.5.1 As far as possible, girders as per RDSO design shall be adopted for spans above railway tracks. Time and again Railway Board has issued instructions to adopt standard designs of ROB girders from safety consideration as well as to expedite execution of work. However in unavoidable circumstances non-RDSO spans can be used due to site constraints.

2.5.2 For shorter spans, it is preferable to adopt Composite Steel Plate type Girders as these are comparatively easier to fabricate and erect. But the limitation with the use of Composite Steel Plate Girder type spans is, as the span becomes longer, the depth of the girder keeps on increasing. This results in higher level of deck slabs over Railway



portion. To ramp out these higher levels in Railway portion, the approaches become longer. In densely populated areas, urban settlements and in other site conditions, it is not only undesirable but also the overall cost may go up as the length of ROB is getting increased. Therefore for longer spans, Bow String Arch type or Truss type Open Web Girders may be adopted as they offer lesser increase in deck level in comparison to Composite Steel Plate type girders.

## 2.6 Skew arrangement:

2.6.1 The term 'angle of skew' or 'skew angle' is the angle between the axis of support (pier) and a line normal to the longitudinal axis of a bridge.

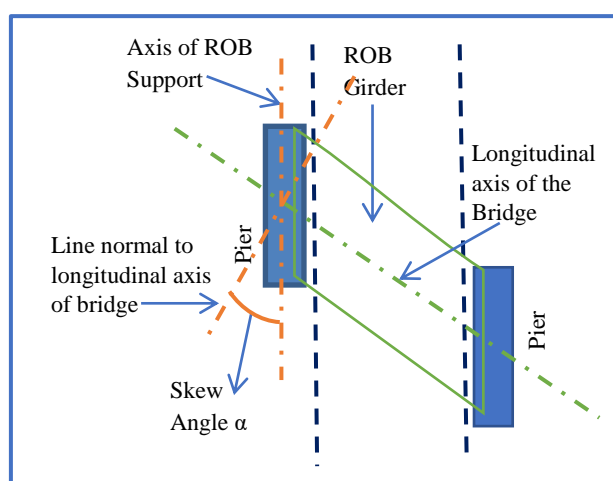

**Figure 1** Defining Skew Angle  $\alpha$

2.6.2 Lots of demands for design of skew girder Road Over Bridges are faced by the railways, especially for national highways where owing to higher speeds; road authorities are reluctant to introduce any curves in the road alignment. Sometimes skew arrangement is required at congested sites where change of alignment is not possible. Demands for skew angles as high as  $70^\circ$  have been noticed. It must be noticed that skew girders have the supports quite away from the natural line of transfer of loads and as a result the girders are subjected to high torsional loads as well as extra bending moments on the obtuse corner. The acute corners are subjected to uplift as a result of the asymmetry of the load due to the skew girders.

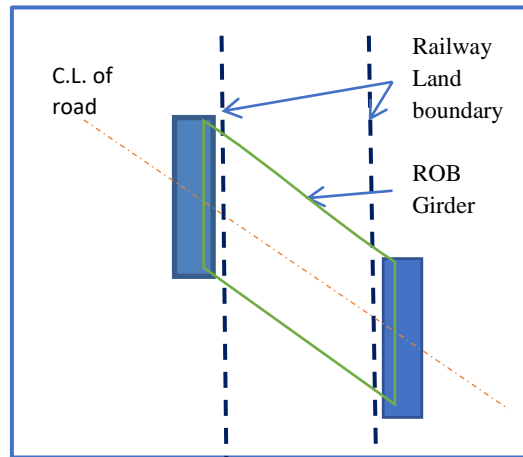

**Figure 2** Normal method of providing skew spans

2.6.3 Larger skew angles are not desirable as capturing the proper behaviour of girder at larger skew angles is not easy. Providing sufficient torsional restraint is also difficult. Therefore, efforts shall be made to get to square alignment, if possible, or to reduce skew angles to within limits. Latest instructions regarding skew angles to be adopted in the Road Over Bridges (ROBs) issued by Railway Board is being attached as Annexure -II for ready reference.

2.6.4 Advantages of reducing skew angles:

- a) It is easier to provide the square alignment girders and chances of mistakes in fabrication as well as assembly are less.
- b) Behaviour of skew girders under seismic loads is inferior to the square arrangement. The skew arrangements are under “not desirable” arrangement, in the various codes.
- c) The behavior of square spans and skew girders with less than  $20^{\circ}$  skew angle is more preferable and easily understood. Errors of design are likely to be lesser.
- d) Square girders can be adopted for lower skew angles upto  $20^{\circ}$  and the fabrication is easier in such cases.

2.6.5 Methods for reducing skew angles (Providing square girders, if feasible) in Road Over Bridges: Various strategies can be tried individually or in combinations to reduce the skew angle as much as

possible. Choice of strategy/ combination thereof will depend on site conditions. The strategies and constraints in adopting the same are discussed below:

**A. Providing longer spans:** If space constraint is not there, providing longer span can help in reducing or eliminating skew angle. In such a case, the sub structure is skew to railway alignment but the ROB girders are square or at lesser skew angle.

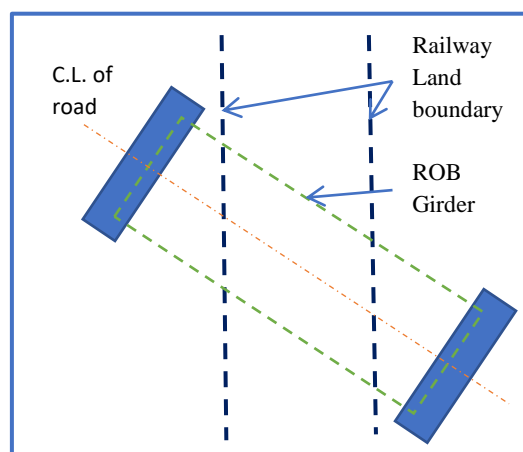

**Figure 3** Skew alignment made square by providing longer span.

**Constraints:**

- a) The span is longer, so the depth of girder might go up theoretically. (Does not happen practically as some margin is kept to take care of the extra bending moments and torsion due to skew).
- b) The piers are not parallel to railway land boundary. So if the piers are being built in railway land, the width of land rendered unusable for future is increased.
- c) Standard design of longer span required, if not available, the design will have to be done afresh.

**B. Constructing sub structure in skew to railway land boundary:** It is not mandatory that the sub structure shall be parallel to railway land boundary even though it is desirable to reduce the railway land permanently rendered unusable. If the space constraint is not there, the sub structure can be constructed in

skew to the railway land boundary, thus reducing the skew angle of the girders to within 20 degrees.

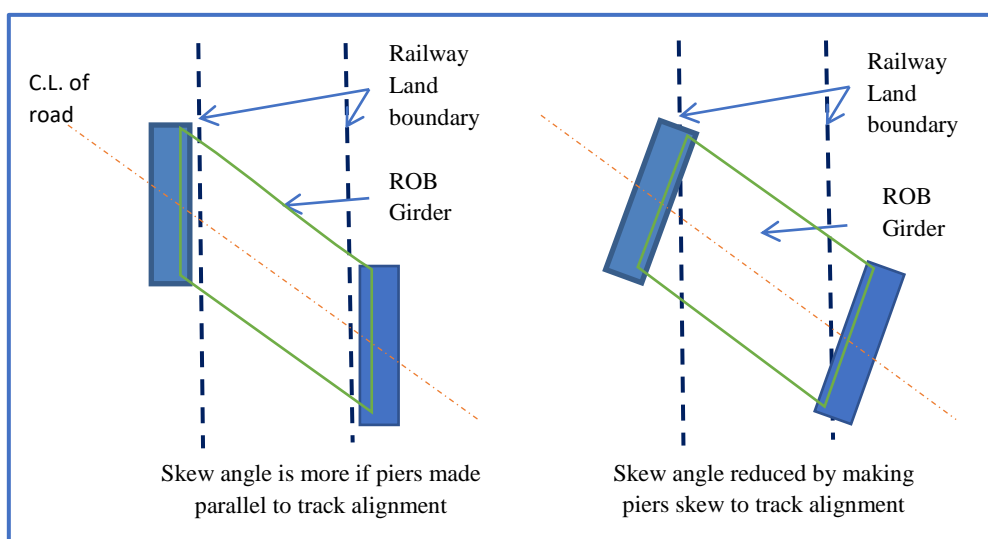

**Figure 4 On left:** Normally provided skew girder; **On right:** Skew sub structure constructed to reduce skew angle (without change in span)

**Constraints:**

- a) The piers are not parallel to railway land boundary. So if the piers are being built in railway land, the width of land rendered unusable for future is increased.
- b) The skew piers can violate the Schedule of Dimensions of existing or future tracks. This needs to be checked.

**C. Constructing Skew bed block:** Land is a precious resource and at lots of locations, railways might require the entire railway land boundary for its current and future operations and the land on approaches might also not be available. In this situation, both the options a) and b) discussed above will not be feasible. Option b) might not be desirable if the standard girder design is not available for the longer length contemplated. In such situations, an option can be to construct the foundation and the sub structure parallel to railway land boundary occupying minimum width, but to reduce the skew angle of the girder, the bed block can be made in skew. In this approach, the land is not wasted and the extra width in bed block is provided above the Schedule



of Dimensions so that maximum space is useable, without affecting the train operations.

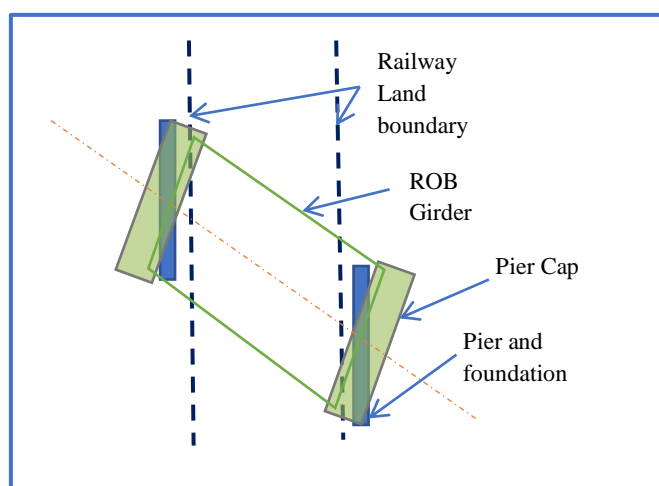

**Figure 5** Arrangement with pier cap in skew

**Constraints:**

- a) The cantilever length of pier cap is increased. The depth of pier cap can increase.
- b) The skew piers can violate the Schedule of Dimensions of existing or future tracks. This needs to be checked.

**D. Altering shape of Pier Cap:** The lateral clearance requirement as per Schedule Of Dimensions (SOD) is lesser at more height above the rail level compared to lesser heights. Therefore, the pier wall/columns can be built at lesser distance from center line of track as compared to the bed block. In order to reduce this lateral distance, few steps can be taken.

- a) The most obvious step is to construct a tapered pier cap, to suit the requirement of the section modulus as per shape of bending moment diagram. Due to the tapered shape, pier cap can be constructed closer to the running line than a rectangular one.
- b) One innovation suggested by Northern Railway construction organization is to construct the pier cap at a level higher than the conventional height without changing the road level. For this, the girders shall be provided in pockets made in the pier cap rather than at the top of the pier on a pedestal. The

bearings can be provided in this pocket and thus the height from rail level to the bottom of the pier cap can be more than that in conventional pier caps without affecting the clearance below the girders or the road level. The height of the end diaphragms shall be reduced so that jacking can be done from outside the pockets. The schematic arrangement is shown below:

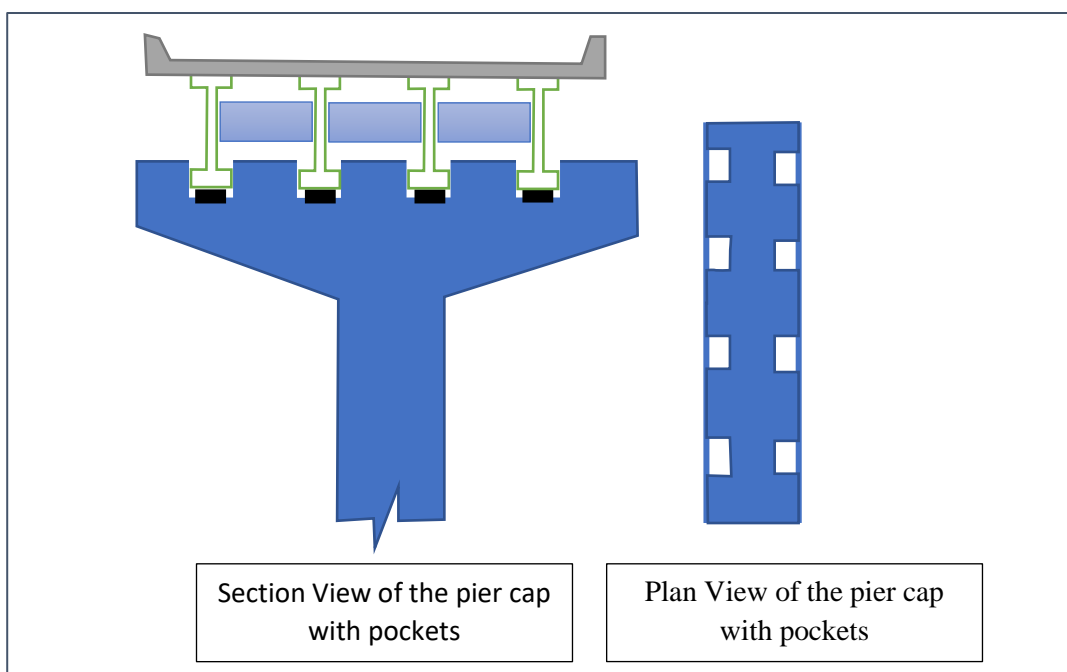

**Figure 6** Arrangement with pockets to accommodate girders

**E. Providing fish bellied girders:** Another method for increasing the height of pier cap from ground is to construct fish bellied girders as shown below.

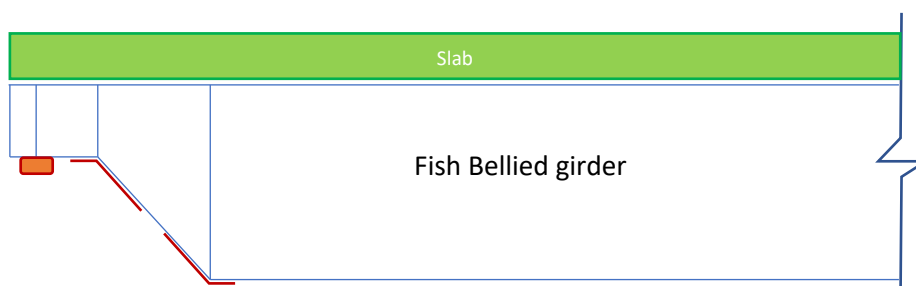

**Figure 7:** Cross sectional view of a fish bellied girder

**Disadvantage:** Fish bellied girders are slightly difficult to fabricate and require splice in bottom flange as well as web.

**F. Providing portal across the track:** A very good method to reduce the skew angle is to rest the girders on portal provided across the track rather than on the piers directly. This method is used by Metros to cross the roads and other obstructions. Casting the beam of the portal over running track is very difficult and shall be avoided. To solve this issue and also to ensure that the road level is not increased un-necessarily, beam of the portal can be a steel beam and the girders of the road over bridge shall be connected to the web of this beam. This arrangement can utilize the standard RDSO girders by eliminating the bearing stiffener and the bearings under the girders. The bearings in this case shall be provided under the cross girder of the portal. The arrangement of the piers for the portal shall be as shown in figure 8 below:

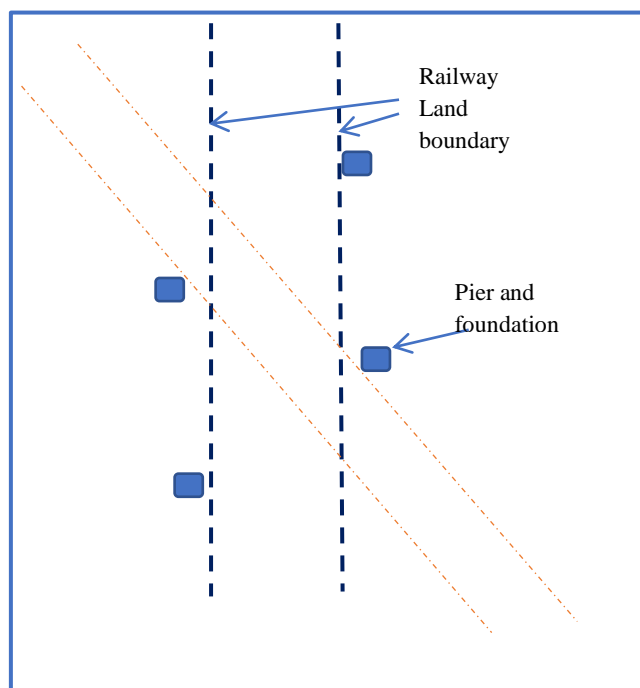

**Figure 8** Layout of piers for the portal construction

The portal beam shall be provided over the piers such that the beam is normal to the road alignment. Bearings (POT-PTFE) shall be provided under the portal beam as shown in figure 9.

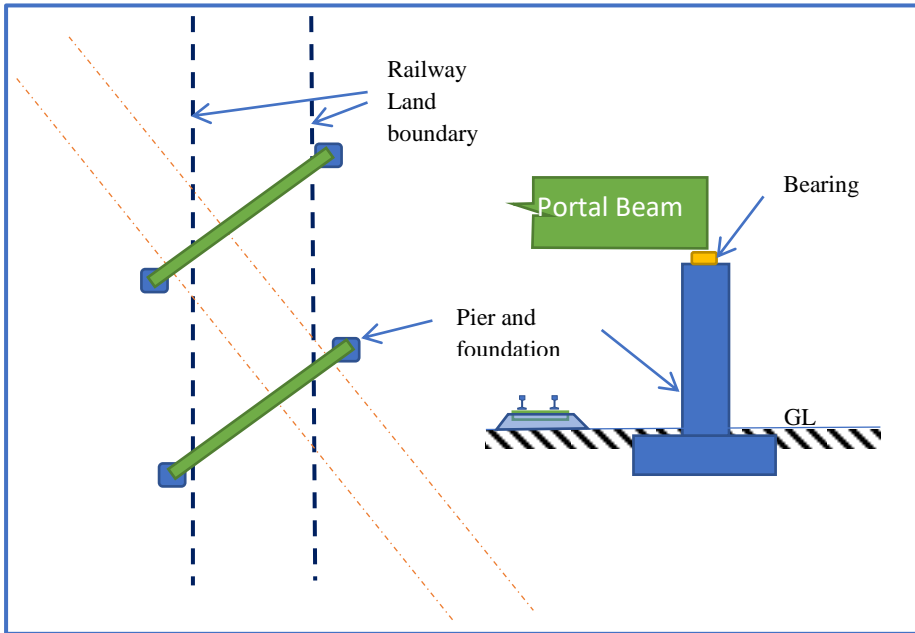

**Figure 9** Beams for portal

The beams for the ROB shall be supported on bearing stiffener in the web of the portal beam. The layout is as shown in figure 10 below:

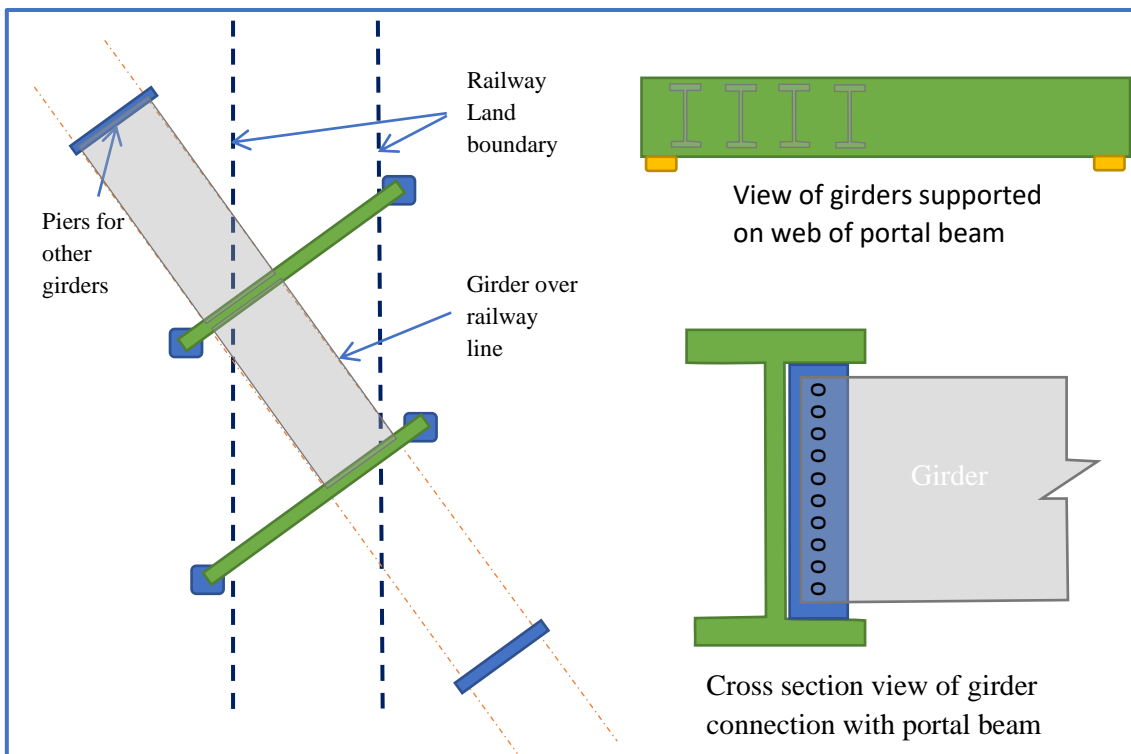

**Figure 10** Provision of girders on the portal

This arrangement can be used as per site conditions and if the skew angle is too much, then multiple spans can be provided over the railway track, with suitably designed portal beams/ piers.

**2.7 Conclusion:** Good planning of Road Over Bridges (ROBs) is an important activity and all efforts shall be made for arriving at a plan wherein interests of Railways as well as State Government/ Road Authority are protected. A thoughtful consideration on above discussed points can help in arriving at a plan which does not put unwanted constraints on designers as well as execution team.

**2.8 Summary:**

2.8.1 The pages ahead contain list of various approved ROB drawings. These include RDSO standard drawings as well as other drawings. The purpose is to eliminate time required in designing and developing detailed drawings of ROB girder in each use case. This compendium is basically a repository of available drawings, catalogued properly to easily find the best suitable girder for a specific use case. A summary of these drawings is as follows-

	RDSO Drawings			Non-RDSO Drawings		
	CG	BSG & Truss	Total	CG	BSG & Truss	Total
With SV Loading	4	11	15	83	23	106
Other than SV Loading	4	11	15	63	19	82

2.8.2 All these drawings have been made available to all Railway officials on RDSO Railnet website i.e. <http://10.100.2.4/drawing/frmLink.aspx>.

2.8.3 Users are requested to take help of index given in following pages for easy identification of drawing for their specific use case depending upon loading, span, skew angle and carriage way width.

### Index of Drawings for Special Vehicle (SV) Loading

(In Chapter III, Page 25 to 80, S. No. 1 to 121)

Span (m)	Skew (degree)	Carriage Way Width (m)				
		5.3 to 9.6	9.6 to 13.1	13.1 to 16.6	16.6 to 20.1	> 20.1
		Serial number of the drawings in Chapter III				
Upto 24	0			79		
	>0 & ≤ 30	1, 2	1, 2, 33, 90, 91	80		
	>30 & ≤ 45					
	> 45	45				46
>24 & ≤30	0	32	34			
	>0 & ≤ 30	3	35, 3,	81		
	>30 & ≤ 45					
	> 45	47	48, 49, 93			
>30 & ≤36	0			95		
	>0 & ≤ 30	4	4, 36, 37, 74, 82	86		73, 85
	>30 & ≤ 45	50	84, 94, 119			
	> 45		51, 52, 83			118
>36 & ≤42	0	5, 97	38, 99, 100	6		
	>0 & ≤ 30	76	39, 98, 120			
	>30 & ≤ 45	75	96			
	> 45	53				
>42 & ≤48	0	7, 17, 18, 29, 21, 101, 103	16, 40, 41, 56, 57, 58, 59. 88,116	8		
	>0 & ≤ 30	19, 44, 106, 107	44, 104, 105, 108, 110	102, 109, 111		
	>30 & ≤ 45					
	> 45	54	55			87
>48 & ≤54	0	9, 22, 23, 24, 26, 28	42, 77, 112	89	60, 61	
	>0 & ≤ 30	25	27, 92			
	>30 & ≤ 45					121
	> 45					
>54 &	0	11,	12, 29, 64	10, 13,	62, 63, 65	

Span (m)	Skew (degree)	Carriage Way Width (m)				
		5.3 to 9.6	9.6 to 13.1	13.1 to 16.6	16.6 to 20.1	> 20.1
		Serial number of the drawings in Chapter III				
≤60		114		115		
	>0 & ≤ 30		31, 113			
	>30 & ≤ 45	30				
	> 45					
>60 & ≤66	0		43, 66, 69, 78		67, 68	
	>0 & ≤ 30					
	>30 & ≤ 45					
	> 45					70
>66 & ≤72	0	14	117	15		
	>0 & ≤ 30					
	>30 & ≤ 45					
	> 45	71				
>72 & ≤78	0					
	>0 & ≤ 30					
	>30 & ≤ 45					
	> 45					
>78 & ≤84	0		72			
	>0 & ≤ 30					
	>30 & ≤ 45					
	> 45					



## Index of Drawings for other than Special Vehicle Loading

(In Chapter IV, Page 81 to 130, S. No. 1 to 97)

Span (m)	Skew (degree)	Carriage Way Width (m)				
		5.3 to 9.6	9.6 to 13.1	13.1 to 16.6	16.6 to 20.1	> 20.1
Serial number of the drawings in Chapter IV						
Upto 24	0	22, 49				
	>0 & ≤ 30	1, 2, 51, 53	1, 2, 50, 55			
	>30 & ≤ 45	52, 54				
	> 45					
>24 & ≤30	0	5, 26				
	>0 & ≤ 30	3, 16, 24, 25, 58, 61, 62	3			
	>30 & ≤ 45	23, 57, 59, 60				
	> 45	56		86		
>30 & ≤36	0	6, 64				40
	>0 & ≤ 30	4	4, 84			
	>30 & ≤ 45	27, 28, 45, 66, 68	80	87		
	> 45	29, 63, 65, 67	81, 85	86		
>36 & ≤42	0	7, 69	82, 88			
	>0 & ≤ 30		17, 89			
	>30 & ≤ 45	41, 73	75			
	> 45	30, 42, 70, 71, 72, 74				
>42 & ≤48	0	8,9				
	>0 & ≤ 30	31	46			
	>30 & ≤ 45	76	47			90
	> 45					
>48 & ≤54	0	10, 11, 33, 34, 92	78, 91			
	>0 & ≤ 30					
	>30 & ≤ 45					
	> 45	32, 77	35			
>54 & ≤60	0	12, 13, 43	20			
	>0 & ≤ 30					
	>30 & ≤ 45					
	> 45					
>60 &	0	79	36, 44	93		

Span (m)	Skew (degree)	Carriage Way Width (m)				
		5.3 to 9.6	9.6 to 13.1	13.1 to 16.6	16.6 to 20.1	> 20.1
		Serial number of the drawings in Chapter IV				
≤66	>0 & ≤ 30					
	>30 & ≤ 45					
	> 45					
>66 & ≤72	0	14, 15, 18, 95	94			
	>0 & ≤ 30					
	>30 & ≤ 45					
>72 & ≤78	> 45					
	0	38	19, 37			
	>0 & ≤ 30					
>78 & ≤84	>30 & ≤ 45					
	> 45					
	0		83			
>84 & ≤90	>0 & ≤ 30					
	>30 & ≤ 45					
	> 45		97			
>90 & ≤96	0	96				
	>0 & ≤ 30					
	>30 & ≤ 45					
>96 & ≤102	> 45					
	0					
	>0 & ≤ 30					
>102 & ≤108	>30 & ≤ 45					
	> 45		48			
	0	21				
>108 & ≤114	>0 & ≤ 30			39		
	>30 & ≤ 45					
	> 45					

This page is left blank intentionally.

**Chapter III**  
**List of Drawings suitable for**  
**Special Vehicle Loading**

This page is left blank intentionally.

## **List of RDSO drawings for Special Vehicle Loading**

<b>List of RDSO Standard Drawings of Composite Plate Girder</b>					
Sl.No.		1			
Sub Sl.No.		1			
Drawing Identification No.	1	RDSO/B-11772			
Whether Fit for SV Loading	2	Yes			
Designed with Congestion Factor (Y/N)	3	Yes			
Month/ Year of Design (MM/YYYY)	4	10/2016			
Month/ Year of Approval (MM/YYYY)	5	10/2016			
Span (m)	6	18			
Depth of Girder (mm)	7	865			
Seismic Zone designed for	8	V			
Angle of Skew designed for	9	Upto 20			
Degree of curvature designed for	10	Upto 10			
Number of Girders in one span	11	5	6	6	
Carriageway Width (mm)	12	8500	10500	11000	
Number of lanes	13	2	3	2	
Direction of road traffic	14	One way	One way	Two way	
Deck Width (mm)	15	12300	15300	15600	
Deck Configuration	As per which IRC Special Publication No. & Year	16	SP:84-2014	SP:87-2013	SP:73-2015
	Footpath (Nil/One-side/Two-side)	17	One side	One side	Both side
	Kerb (Nil/One-side/Two-side)	18	Two side	Two side	Nil
	Crash Barrier {Number-Type (RCC/ W-Beam /Others)}	19	Two side RCC	Two side RCC	Two side RCC
	Railing (RCC/Steel/Others)	20	One side Steel	One side Steel	Two side Steel



<b>List of RDSO Standard Drawings of Composite Plate Girder</b>									
	2			3			4		
	2			3			4		
1	RDSO/B-11773			RDSO/B-11774			RDSO/B-11775		
2	Yes			Yes			Yes		
3	Yes			Yes			Yes		
4	12/2016			12/2016			12/2016		
5	12/2016			12/2016			12/2016		
6	24			30			36		
7	1220			1325			1581		
8	V			V			V		
9	Upto 20			Upto 20			Upto 20		
10	Upto 10			Upto 10			Upto 10		
11	5	6	6	5	6	6	5	6	6
12	8500	10500	11000	8500	10500	11000	8500	10500	11000
13	2	3	2	2	3	2	2	3	2
14	One way	One way	Two way	One way	One way	Two way	One way	One way	Two way
15	12300	15300	15600	12300	15300	15600	12300	15300	15600
16	SP:84-2014	SP:87-2013	SP:73-2015	SP:84-2014	SP:87-2013	SP:73-2015	SP:84-2014	SP:87-2013	SP:73-2015
17	One side	One side	Both side	One side	One side	Both side	One side	One side	Both side
18	Two side	Two side	Nil	Two side	Two side	Nil	Two side	Two side	Nil
19	Two side RCC	Two side RCC	Two side RCC	Two side RCC	Two side RCC	Two side RCC	Two side RCC	Two side RCC	Two side RCC
20	One side Steel	One side Steel	Two side Steel	One side Steel	One side Steel	Two side Steel	One side Steel	One side Steel	Two side Steel

<b>List of RDSO Standard Drawings of Bow String Arch Girder</b>				
Sl.No.			5	6
Sub Sl.No.			1	2
Drawing Identification Number		1	RDSO/B-10414/R	RDSO/B-10430
Whether Fit for Special Vehicle Loading of IRC-6:2017		2	Yes	Yes
Whether Designed with Congestion Factor		3	Yes	Yes
Month/Year of Design		4	Oct-19	Jan-22
Month Year of Approval of Design		5	-	Feb-22
Span (m)		6	42	42
Depth of Girder from bottom of girder to top of deck slab (mm)		7	1210	1558
Number of Girders in one span		8	1	1
Seismic Zone designed for		9	V	V
Angle of Skew designed for		10	0	0
Degree of curvature designed for		11	0	0
Carriageway Width (mm)		12	9500	14000
Number of lanes		13	2	3
Direction of road traffic		14	One way	One way
Deck Width (mm)		15	12200	17000
Deck Configuration	As per which IRC Special Publication No. & Year	16	-	SP 87:2019
	Footpath (Nil/One-side/Two-side)	17	One side	One side
	Kerb (Nil/One-side/Two-side)	18	Nil	Nil
	Crash Barrier {Numbers-Type (RCC/W-Beam/Others)}	19	RCC	RCC
	Railing (RCC/Steel/Others)	20	Steel	W-Beam

<b>List of RDSO Standard Drawings of Bow String Arch Girder</b>				
	7	8	9	10
	3	4	5	6
1	RDSO/B-10416/R	RDSO/B-10429	RDSO/B-10417/R	RDSO/B-10428
2	Yes	Yes	Yes	Yes
3	Yes	Yes	Yes	Yes
4	Dec-19	Dec-21	Feb-20	Nov-21
5	-	Dec-21	-	Nov-21
6	48	48	54	56
7	1210	1558	1210	1595
8	1	1	1	1
9	V	V	V	V
10	0	0	0	0
11	0	0	0	0
12	9500	14000	9500	14000
13	2	3	2	3
14	One way	One way	One way	One way
15	12200	17000	12200	17000
16	-	SP 87:2019	-	SP 87:2019
17	One side	One side	One side	One side
18	Nil	Nil	Nil	Nil
19	RCC	RCC	RCC	RCC
20	Steel	W-Beam	Steel	W-Beam

<b>List of RDSO Standard Drawings of Bow String Arch Girder</b>				
Sl.No.			11	12
Sub Sl.No.			7	8
Drawing Identification Number		1	RDSO/B-10415/R	RDSO/B-10423/1R
Whether Fit for Special Vehicle Loading of IRC-6:2017		2	Yes	Yes
Whether Designed with Congestion Factor		3	Yes	Yes
Month/Year of Design		4	Feb-20	Jun-20
Month Year of Approval of Design		5	-	-
Span (m)		6	60	60
Depth of Girder from bottom of girder to top of deck slab (mm)		7	1210	1505
Number of Girders in one span		8	1	1
Seismic Zone designed for		9	V	IV
Angle of Skew designed for		10	0	0
Degree of curvature designed for		11	0	0
Carriageway Width (mm)		12	9500	10500
Number of lanes		13	2	2
Direction of road traffic		14	One way	Two way
Deck Width (mm)		15	12200	14700
Deck Configuration	As per which IRC Special Publication No. & Year	16	-	SP 73: 2015
	Footpath (Nil/One-side/Two-side)	17	One side	Both side
	Kerb (Nil/One-side/Two-side)	18	Nil	Nil
	Crash Barrier {Numbers-Type (RCC/W-Beam/Others)}	19	RCC	RCC
	Railing (RCC/Steel/Others)	20	Steel	Steel

<b>List of RDSO Standard Drawings of Bow String Arch Girder</b>			
	13	14	15
	9	10	11
1	RDSO/B-10427	RDSO/B-10418/R	RDSO/B-10425
2	Yes	Yes	Yes
3	Yes	Yes	Yes
4	Sep-21	Oct-19	Jun-21
5	Sep-21	-	Jun-21
6	60	72	72
7	1595	1210	1758
8	1	1	1
9	V	V	V
10	0	0	0
11	0	0	0
12	14000	9500	14000
13	3	2	3
14	One way	One way	One way
15	17000	12200	17000
16	SP 87:2019	-	SP 87:2019
17	One side	One side	One side
18	Nil	Nil	Nil
19	RCC	RCC	RCC
20	W-Beam	Steel	W-Beam

This page is left blank intentionally.

**List of Non-RDSO drawings for Special Vehicle  
Loading**



CENTRAL RAILWAY				
Sl. No.			16	17
Sub Sl. No.			1	2
Drawing Identification Code		1	SV-CR-CG-01	SV-CR-CG-02
Designed by whom	Railway (CBE/CAO)	2	-	-
	PSU	3	MRIDCL	MRIDCL
Name of Consultant, if any	Design Consultant	4	MRIDCL	MRIDCL
	Proof Consultant	5	IIT Mumbai	IIT Mumbai
Drawing Number		6	MRIDL/CSMT/R OB/SS/43	MRIDC/CR/NGP/ROB /LC-39AB/SS/43.0 Series
Whether Fit for Special Vehicle Loading of IRC-6:2017		7	Yes	Yes
Whether Designed with Congestion Factor		8	Yes	Yes
Month/Year of Design		9	Feb.20	Feb-20
Month Year of Approval of Design		10	Mar.20	Apr-20
Stations/Locations where used		11	Turbhe-Mumbai	LC No. 39AB at km 865/16-866/1 between TADLI-MOORSA station
Type of Superstructure		12	Composite steel girder	Composite steel girder
Span (m)		13	43	43
Depth of Girder including deck slab (mm)		14	2650	2650
Number of Girders in one span		15	6	5
Seismic Zone designed for		16	III	III
Angle of Skew (Degrees)		17	0	0
Degree of curvature designed for		18	0	0
Carriageway Width (mm)		19	11000	8500
Number of lanes		20	2	2
Direction of road traffic		21	Two way	One way
Deck Width (mm)		22	14000	12300
Deck Configuration	As per which IRC Special Publication No. & Year	23	-	SP 84-2014
	Footpath (Nil/One-side/Two-side)	24	One side	One side
	Kerb (Nil/One-side/Two-side)	25	Nil	Nil
	Crash Barrier {Number- Type (RCC/ W-Beam /Others)}	26	Both side RCC	Both side RCC
	Railing (RCC/ Steel/Others)	27	One side	One side

<b>CENTRAL RAILWAY</b>				
	18	19	20	21
	3	4	5	6
1	SV-CR-CG-03	SV-CR-CG-04	SV-CR-CG-05	SV-CR-CG-06
2	-	-	-	-
3	MRIDCL	MRIDCL	MRIDCL	MRIDC
4	MRIDCL	MRIDCL	MRIDCL	MRIDCL
5	IIT Mumbai	IIT Mumbai	IIT Mumbai	IIT Mumbai
6	MRIDC/WS/R OB/LC- 105/SS /43	MRIDC/CR/NGP/ ROB/LC- 290B/SS/43	MRIDC/CSMT/RO B/MANKHURD/G A/SS/43.6	MRIDC/CR/BSL/ ROB/LC- 147/GN/45
7	Yes	Yes	Yes	Yes
8	Yes	Yes	Yes	Yes
9	Feb-20	Mar-20	Feb-20	Jul-20
10	Mar.-20	Apr-20	Mar.-20	Sep-21
11	LC 105 of Dondhaiche- Vikhran Road	Kalmeshwar- Bharatwada station	Mankhurd- Mumbai	Shiroli- Jalgaon
12	Composite steel girder	Composite steel girder	Composite steel girder	Composite steel girder
13	43	43	43.6	45
14	2650	2650	2650	2650
15	5	5	4	5
16	III	III	III	II
17	0	6	0	0
18	0	0	0	0
19	8500	8500	7500	8500
20	2	2	2	2
21	One way	One way	One way	One way
22	12300	12300	10000	12300
23	SP 84-2014	SP 84-2014	-	SP 84-2014
24	One side	One side	One side	One side
25	Nil	Nil	Nil	Nil
26	Both side RCC	Both side RCC	Both side RCC	Both side RCC
27	One side	Both side	Nil	One side



CENTRAL RAILWAY				
Sl.No.			22	23
Sub Sl. No.			7	8
Drawing Identification Code		1	SV-CR-CG-07	SV-CR-CG-08
Designed by whom	Railway (CBE/CAO)	2	-	-
	PSU	3	MRIDCL	MRIDCL
Name of Consultant, if any	Design Consultant	4	MRIDCL	MRIDCL
	Proof Consultant	5	IIT Mumbai	IIT Mumbai
Drawing Number		6	MRIDC/CR/BSL/ROB/LC-1/GN/51	MRIDC/CR/BSL/ROB/LC-95/SS/51
Whether Fit for Special Vehicle Loading of IRC-6:2017		7	Yes	Yes
Whether Designed with Congestion Factor		8	Yes	Yes
Month/Year of Design		9	Mar-20	Mar-20
Month Year of Approval of Design		10	Apr-20	Mar-20
Stations/Locations where used		11	LC S1 At Km 664/11-12 Of Badnera-Amravati	Igatpuri-Bhusawal Section of CR
Type of Superstructure		12	Composite steel girder	Composite steel girder
Span (m)		13	51	51
Depth of Girder including deck slab (mm)		14	2750	2750
Number of Girders in one span		15	4	6
Seismic Zone designed for		16	III	III
Angle of Skew (Degrees)		17	0	0
Degree of curvature designed for		18	0	0
Carriageway Width (mm)		19	7500	7500
Number of lanes		20	2	2
Direction of road traffic		21	One way	One way
Deck Width (mm)		22	10000	12300
Deck Configuration	As per which IRC Special Publication No. & Year	23	-	-
	Footpath (Nil/One-side/Two-side)	24	One side	Two side
	Kerb (Nil/One-side/Two-side)	25	Nil	Nil
	Crash Barrier {Number- Type (RCC/ W-Beam /Others)}	26	Both side RCC	Both side RCC
	Railing (RCC/ Steel/Others)	27	Nil	Both side

<b>CENTRAL RAILWAY</b>				
	24	25	26	27
	9	10	11	12
1	SV-CR-CG-09	SV-CR-CG-10	SV-CR-CG-11	SV-CR-CG-12
2	-	-	-	-
3	MRIDCL	MRIDCL	MRIDCL	MRIDCL
4	MRIDCL	MRIDCL	MRIDCL	MRIDCL
5	IIT Mumbai	IIT Mumbai	IIT Mumbai	IIT Mumbai
6	MRIDC/CR/NGP/ROB/LC-282/SS/51	MRIDC/CR/ROB/177/SS/51	MRIDC/CR/NGP/ROB/LC-282A/SS/51.0	MRIDC/CR/BSL/ROB/LC-171/SS/53
7	Yes	Yes	Yes	Yes
8	Yes	Yes	Yes	Yes
9	Mar-20	Mar-20	Mar-20	Mar-20
10	Mar-20	Apr-20	Mar-20	April-20
11	Kalambha Katol Station Jalkheda Road, Nagpur	LC 117 of Bhilavadi and Nadre	LC 282A of Kalambha-Katol station	Bhusawal- Itarsi Section
12	Composite steel girder	Composite steel girder	Composite plate girder	Composite steel girder
13	51	51	51	53
14	2750	2750	2750	3050
15	5	5	5	6
16	III	III	III	III
17	0	20	0	19
18	0	0	0	0
19	8500	8500	8500	11000
20	2	2	2	2
21	One way	One way	One way	Two way
22	12300	12300	12300	15600
23	IRC SP-84 2014	IRC SP-84 2014	IRC SP-84: 2014	IRC SP-73: 2015
24	One side	One side	One side	Both side
25	Nil	Nil	Nil	Nil
26	Both side RCC	Both side RCC	Both side RCC	Both side RCC
27	One side	One side	One side	Both side

CENTRAL RAILWAY				
Sl. No.			28	29
Sub Sl. No.			13	14
Drawing Identification Code		1	SV-CR-CG-13	SV-CR-CG-14
Designed by whom	Railway (CBE/CAO)	2	-	-
	PSU	3	MRIDCL	MRIDCL
Name of Consultant, if any	Design Consultant	4	MRIDCL	MRIDCL
	Proof Consultant	5	IIT Mumbai	IIT Mumbai
Drawing Number		6	MRIDC/CR/NGP /ROB/LC-27/SS/53	MRIDC/CSTM/ROB/TURBHE/54.5
Whether Fit for Special Vehicle Loading of IRC-6:2017		7	Yes	Yes
Whether Designed with Congestion Factor		8	Yes	Yes
Month/Year of Design		9	Mar-20	Nov-19
Month Year of Approval of Design		10	April-20	Jan-20
Stations/Locations where used		11	Wardha Station, Ballarshah, Nagpur	Sion-Panvel (Turbhe)
Type of Superstructure		12	Composite steel girder	Composite steel girder
Span (m)		13	53	54.5
Depth of Girder including deck slab (mm)		14	3050	3200
Number of Girders in one span		15	5	6
Seismic Zone designed for		16	III	III
Angle of Skew (Degrees)		17	0	0
Degree of curvature designed for		18	0	0
Carriageway Width (mm)		19	8500	11000
Number of lanes		20	2	2
Direction of road traffic		21	One way	One way
Deck Width (mm)		22	12300	14000
Deck Configuration	As per which IRC Special Publication No. & Year	23	IRC SP-84: 2014	-
	Footpath (Nil/One-side/Two-side)	24	One side	One side
	Kerb (Nil/One-side/Two-side)	25	Nil	Nil
	Crash Barrier {Number- Type (RCC/ W-Beam /Others)}	26	Both Side RCC	Both Side RCC
	Railing (RCC/Steel/Others)	27	One side	One side

CENTRAL RAILWAY		
	30	31
	15	16
1	SV-CR-CG-15	SV-CR-CG-16
2	DY. CE	DY. CE
3	NHAI	NHAI
4	Accerete Consulting Engineers Pvt Ltd	HCC Infra Consultants
5	VJTI Mumbai	IIT Mumbai
6	1066/TAR-FAG/NH-6/ST/ROB/426+781/204	CIPL/D1036/ROB/STR/GAD/DWG/401
7	Yes	Yes
8	Yes	Yes
9	Dec-20	Jun-20
10	Jul-21	Dec-20
11	Tarsod-Fagne	Warora-Wani
12	Composite steel girder	Composite steel girder
13	58	58
14	2815	3577
15	7	7
16	III	III
17	33.3	15.537
18	0	0
19	9000	12000
20	2	3
21	One Way	One Way
22	12000	16500
23	-	-
24	One Side	One Side
25	Nil	Nil
26	Both Side RCC	Both Side RCC
27	RCC	RCC

This page is left blank intentionally.



<b>EASTERN RAILWAY</b>			
Sl. No.			32
Sub Sl. No.			1
Drawing Identification Code		1	SV-ER-CG-01
Designed by whom	Railway (CBE/CAO)	2	CBE
	PSU	3	-
Name of Consultant, if any	Design Consultant	4	L & T Infrastructure Engineering Ltd.
	Proof Consultant	5	IIT Madras
Drawing Number		6	GAD-Drg.No-B-216-2020
Whether Fit for Special Vehicle Loading of IRC-6:2017		7	Yes
Whether Designed with Congestion Factor		8	Yes
Month/Year of Design		9	Sep-21
Month Year of Approval of Design		10	Sep-21
Stations/Locations where used		11	Tala Rly Station
Type of Superstructure		12	Composite girder
Span (m)		13	25.17
Depth of Girder including deck slab (mm)		14	1575
Number of Girders in one span		15	5
Seismic Zone designed for		16	IV
Angle of Skew (Degrees)		17	0
Degree of curvature designed for		18	0
Carriageway Width (mm)		19	9500
Number of lanes		20	2
Direction of road traffic		21	One way
Deck Width (mm)		22	12200
Deck Configuration	As per which IRC Special Publication No. & Year	23	-
	Footpath (Nil/One-side/Two-side)	24	One side
	Kerb (Nil/One-side/Two-side)	25	Nil
	Crash Barrier {Number-Type (RCC/ W-Beam /Others)}	26	Both side
	Railing (RCC/Steel/Others)	27	One side

<b>EAST CENTRAL RAILWAY</b>				
Sl. No.			33	34
Sub Sl. No.			1	2
Drawing Identification Code		1	SV-ECR-CG-01	SV-ECR-CG-02
Designed by whom	Railway (CBE/CAO)	2	CE/CON/ECR	DY. CE/BR/D/ECR
	PSU	3	-	-
Name of Consultant, if any	Design Consultant	4	Sparsh Engineering Company (P) Limited, Ranchi	Samarth Infra Engg Technocrats Private Limited
	Proof Consultant	5	IIT,BHU,Varanasi	IIT Madras
Drawing Number		6	CAO/CON/MHX DRG. No.7019/ROB-DHN/18	CE'S/ECR/DRG. NO.- ECR/SPJ/2017-18/ROB/231
Whether Fit for Special Vehicle Loading of IRC-6:2017		7	Yes	Yes
Whether Designed with Congestion Factor		8	No	No
Month/Year of Design		9	Dec-17	Feb-17
Month Year of Approval of Design		10	Jan-18	Dec-17
Stations/Locations where used		11	Matari-Gomoh	DMH-BDMA on Purnia-Saharsa
Type of Superstructure		12	Composite Steel Girder	Composite Steel Girder
Span (m)		13	19.99	25
Depth of Girder including deck slab (mm)		14	1504	1914
Number of Girders in one span		15	4	6
Seismic Zone designed for		16	V	V
Angle of Skew (Degrees)		17	20	0
Degree of curvature designed for		18	10	0
Carriageway Width (mm)		19	10500	10500
Number of lanes		20	2	2
Direction of road traffic		21	Two way	Two way
Deck Width (mm)		22	11400	14800
Deck Configuration	As per which IRC Special Publication No. & Year	23	-	-
	Footpath (Nil/One-side/Two-side)	24	Nil	Both side
	Kerb (Nil/One-side/Two-side)	25	Nil	Nil
	Crash Barrier {Number- Type (RCC/ W-Beam /Others)}	26	Both side RCC	Both side RCC
	Railing (RCC/ Steel/Others)	27	Nil	Both side

<b>EAST CENTRAL RAILWAY</b>				
	35	36	37	38
	3	4	5	6
1	SV-ECR-CG-03	SV-ECR-CG-04	SV-ECR-CG-05	SV-ECR-BSG-01
2	CE/Con/ECR	DY. CE/BR/D /ECR	CE/Con/ECR	CE/Con/ECR
3	-	-	-	-
4	Sparsh Engineering Company (P) Limited, Ranchi	Samarth Infra Engg Technocrats Private Limited	Sparsh Engineering Company (P) Limited, Ranchi	Sparsh Engineering Company (P) Limited, Ranchi- 834 002
5	IIT- BHU, Varanasi	IIT Madras	IIT,BHU,Varanasi	IIT,BHU,Varanasi
6	CAO/CON/MHX , DRG. No. 7017/ ROB- DHN/18	CE'S/ECR/DRG. NO.- ECR/SPJ/2017- 18/ROB/230	CAO/CON/MHX DRG. No. 7018/ROB- DHN/18	CAO/CON/MHX DRG. No. 7023/ROB- DHN/18
7	Yes	Yes	Yes	Yes
8	No	No	No	No
9	Dec-17	Dec-17	Dec-17	Dec-17
10	Jan-18	Jan-17	Jan-18	Jan-18
11	Matari-Gomoh	Birpur -Bihpur	Matari-Gomoh	Matari-Gomoh
12	Composite Steel Girder	Composite Steel Girder	Composite Steel Girder	Bow String Steel Girder
13	29.702	31.25	32.08	36.98
14	2063	2850	2063	2284
15	5	6	4	2
16	V	V	V	III
17	20	20	20	0
18	10	0	10	0
19	10500	10500	10500	10500
20	2	2	2	2
21	Two way	Two way	Two way	Two way
22	14800	14800	11400	14800
23	-	-	-	-
24	Both Side	Both sides	Nil	Both sides
25	Nil	Nil	Nil	Nil
26	Both side RCC	Both side RCC	Both side RCC	Both side RCC
27	Both side	Both sides	Nil	Both side

<b>EAST CENTRAL RAILWAY</b>				
Sl. No.			39	40
Sub Sl. No.			7	8
Drawing Identification Code		1	SV-ECR-CG-06	SV-ECR-BSG-02
Designed by whom	Railway (CBE/CAO)	2	CE/Con/ECR	CE/Con/ECR
	PSU	3	-	-
Name of Consultant, if any	Design Consultant	4	Sparsh Engineering Company (P) Limited, Ranchi-834 002	Sparsh Engineering Company (P) Limited, Ranchi-834 002
	Proof Consultant	5	IIT,BHU,Varanasi	IIT,BHU,Varanasi
Drawing Number		6	CAO/CON/MHX DRG. No. 7021/ROB-DHN/18	NGB-LE-ROB-NU-011-14
Whether Fit for Special Vehicle Loading of IRC-6:2017		7	Yes	Yes
Whether Designed with Congestion Factor		8	No	No
Month/Year of Design		9	Dec-17	Mar-20
Month Year of Approval of Design		10	Jan-18	Mar-20
Stations/Locations where used		11	Matari-Gomoh	Patna Sahib-Banka Ghat
Type of Superstructure		12	Composite Girder	Bow String Steel Girder
Span (m)		13	36.98	44
Depth of Girder including deck slab (mm)		14	2445	1075
Number of Girders in one span		15	5	2
Seismic Zone designed for		16	V	IV
Angle of Skew (Degrees)		17	20	0
Degree of curvature designed for		18	10	0
Carriageway Width (mm)		19	10500	10500
Number of lanes		20	2	3
Direction of road traffic		21	Two way	One way
Deck Width (mm)		22	11400	15300
Deck Configuration	As per which IRC Special Publication No. & Year	23	-	IRC SP-87:2013
	Footpath (Nil/One-side/Two-side)	24	Nil	Both sides
	Kerb (Nil/One-side/Two-side)	25	Nil	Nil
	Crash Barrier {Number- Type (RCC/ W-Beam /Others)}	26	Both side RCC	Both side RCC
	Railing (RCC/ Steel/Others)	27	Nil	Both side

<b>EAST CENTRAL RAILWAY</b>			
	41	42	43
	9	10	11
1	SV-ECR-BSG-03	SV-ECR-BSG-04	SV-ECR-BSG-05
2	CE/Con/ECR	CE/Con/ECR	-
3	-	-	-
4	Sparsh Engineering Company (P) Limited, Ranchi-834 002	Sparsh Engineering Company (P) Limited, Ranchi-834 002	L&T Infrastructure Engineering Ltd.
5	IIT,BHU,Varanasi	IIT,BHU,Varanasi	IIT Madras
6	CAO/CON/MHX DRG. No. 7020/ROB-DHN/2018	CAO/CON/MHX DRG. No. 7022/ROB-DHN/2018	NGB-LE-ROB-NU-21-29
7	Yes	Yes	Yes
8	No	No	No
9	Dec-17	Dec-17	Mar-20
10	Jan-18	Jan-18	Mar-20
11	Matari-Gomoh	Matari-Gomoh	Chaksikander-Desari
12	Bowstring Steel Girder	Bowstring Steel Girder	Bow String Steel Girder
13	47.42	51.199	62
14	1520	1520	1050
15	2	2	2
16	III	III	IV
17	0	0	0
18	0	0	0
19	10500	10500	10500
20	2	2	3
21	Two way	Two way	One Way
22	14800	14800	15300
23	-	-	IRC SP-87:2013
24	Both sides	Both sides	One side
25	Nil	Nil	Nil
26	Both side RCC	Both side RCC	Both side RCC
27	Both side	Both side	Steel - One Side

This page is left blank intentionally.

<b>EAST COAST RAILWAY</b>			
Sl. No.			44
Sub Sl. No.			1
Drawing Identification Code	1		SV-ECOR-CG-01
Designed by whom	Railway (CBE/CAO)	2	-
	PSU	3	NHAI
Name of Consultant, if any	Design Consultant	4	M/s Dilip Buildcon Limited, Bhopal
	Proof Consultant	5	NIT, Bhopal
Drawing Number	6		CE's Drg. No. 3099/17
Whether Fit for Special Vehicle Loading of IRC-6:2017	7		Yes
Whether Designed with Congestion Factor	8		No
Month/Year of Design	9		07/2020.
Month Year of Approval of Design	10		07/2020.
Stations/Locations where used	11		At Km: 860.505 between stations PDT- KTV
Type of Superstructure	12		Composite Steel Girder
Span (m)	13		44.8
Depth of Girder including deck slab (mm)	14		3157
Number of Girders in one span	15		6 (Main) & 5 (Service)
Seismic Zone designed for	16		II
Angle of Skew (Degrees)	17		12° 22' 25"
Degree of curvature designed for	18		0
Carriageway Width (mm)	19		(10500 + 2000) & 7000
Number of lanes	20		3 lanes & 2 lanes
Direction of road traffic	21		One way
Deck Width (mm)	22		14500 mm & 10800 mm
Deck Configuration	As per which IRC Special Publication No. & Year	23	-
	Footpath (Nil/One-side/Two-side)	24	One side in two lane ROB
	Kerb (Nil/One-side/Two-side)	25	Nil
	Crash Barrier {Number- Type (RCC/ W-Beam /Others)}	26	RCC
	Railing (RCC/Steel/Others)	27	RCC

NORTHERN RAILWAY				
Sl. No.			45	46
Sub Sl. No.			1	2
Drawing Identification Code		1	SV-NR-CG-01	SV-NR-CG-02
Designed by whom	Railway (CBE/CAO)	2	CAO	CAO
	PSU	3	-	-
Name of Consultant, if any	Design Consultant	4	B&S Engineering Consultants Pvt. Ltd.	B&S Engineering Consultants Pvt. Ltd.
	Proof Consultant	5	IIT Delhi	IIT Delhi
Drawing Number		6	P-1540-RB/2018	P-1540-RB/2018
Whether Fit for Special Vehicle Loading of IRC-6:2017		7	Yes	Yes
Whether Designed with Congestion Factor		8	Yes	Yes
Month/Year of Design		9	Jun-20	Jun-20
Month Year of Approval of Design		10	Jun-20	Jun-20
Stations/Locations where used		11	Between Rly Stn Maripat and Ghaziabad	Between Rly Stn Maripat and Ghaziabad
Type of Superstructure		12	Steel Composite Girder	Steel Composite Girder
Span (m)		13	16.998	17.524
Depth of Girder including deck slab (mm)		14	1895	1895
Number of Girders in one span		15	4	12
Seismic Zone designed for		16	IV	IV
Angle of Skew (Degrees)		17	61.574°	60.559°
Degree of curvature designed for		18	0	0
Carriageway Width (mm)		19	9000	9m+15m+2.5m(Cycling Track)
Number of lanes		20	3	2+4=6
Direction of road traffic		21	One way	One way
Deck Width (mm)		22	10000	30300
Deck Configuration	As per which IRC Special Publication No. & Year	23	-	-
	Footpath (Nil/One-side/Two-side)	24	Nil	One side
	Kerb (Nil/One-side/Two-side)	25	Nil	Nil
	Crash Barrier {Number- Type (RCC/ W-Beam /Others)}	26	2 Nos RCC Crash Barrier	3 Nos RCC Crash Barrier
	Railing (RCC/Steel/Others)	27	Nil	Steel



<b>NORTHERN RAILWAY</b>				
	47	48	49	50
	3	4	5	6
1	SV-NR-CG-03	SV-NR-CG-04	SV-NR-CG-05	SV-NR-CG-06
2	-	-	CAO	-
3	-	-	-	-
4	L&T Infrastructure Engineering Limited Chennai	L&T Infrastructure Engineering Limited Chennai	RICE Pvt. Ltd.	ASC Infratech Pvt Ltd
5	IIT Madras	IIT Madras	NIT Kurukshetra	IIT Delhi
6	NRHQE Plan :ROB-107/DLI(SH.7) Series	NRHQE Plan :ROB- 107/DLI(SH.7) Series	P-1705-RB/2019	NRHQE Plan No. ROB/24/UMB SH01TO09
7	Yes	Yes	Yes	Yes
8	No	No	Yes	No
9	Dec-20	Dec-20	Feb-21	Nov-21
10	Jan-21	Jan-21	Feb-21	Nov-21
11	Basai Dhankot Section LC No 29 &30 at Rly KM 37/3-4 & Delhi Rewari Sec.	Basai Dhankot Section LC No 29 & 30 at Rly KM 37/3-4 & Delhi Rewari Sec.	Between Rly Stn Kaithal and Nirwana	Nangala SH on Sutlaj River
12	Steel Composite Girder	Steel Composite Girder	Steel Composite Girder	Steel Composite Girder
13	26.392 to 26.718	26.392 to 26.719	28.36	31.2
14	1695	1695	1640	2085
15	4	6	6	5
16	IV	IV	IV	IV
17	52.056 to 52.406	52.204 to 52.51	58°	43.93
18	0	0	0	0
19	9000	11000	11000	9500
20	2	2	2	2
21	One way	One way	Two way	One way
22	11000	14000	15600	12500
23	-	-	IRC SP 73-2015	-
24	Nil	One side	Both Side	One side
25	Nil	Nil	Nil	One side
26	Both side	Both side	2 Nos RCC Crash Barrier	One side RCC
27	Nil	One side	One side Steel	One side

<b>NORTHERN RAILWAY</b>			
Sl. No.		51	52
Sub Sl. No.		7	8
Drawing Identification Code	1	SV-NR-CG-07	SV-NR-CG-08
Designed by whom	Railway (CBE/CAO)	2	CAO
	PSU	3	-
Name of Consultant, if any	Design Consultant	4	RICE Pvt. Ltd.
	Proof Consultant	5	NIT Kurukshetra
Drawing Number	6	P-1705-RB/2019	NRHQE Plan:ROB-107/DLI/ SH.01 Series
Whether Fit for Special Vehicle Loading of IRC-6:2017	7	Yes	Yes
Whether Designed with Congestion Factor	8	Yes	No
Month/Year of Design	9	Nov-20	Dec-20
Month Year of Approval of Design	10	Nov-20	Jan-21
Stations/Locations where used	11	Between Rly Stn Kaithal and Nirwana	Basai Dhankot Section LC NO 29 and 30 at Railway Km 37/3-4
Type of Superstructure	12	Steel Composite Girder	Steel Composite Girder
Span (m)	13	34.36	35.685 to 37.215
Depth of Girder including deck slab (mm)	14	1945	2085
Number of Girders in one span	15	6	6
Seismic Zone designed for	16	IV	IV
Angle of Skew (Degrees)	17	58°	52.065 to 53.009
Degree of curvature designed for	18	0	0
Carriageway Width (mm)	19	11000	11000
Number of lanes	20	2	3
Direction of road traffic	21	Two Way	One way
Deck Width (mm)	22	15600	14000
Deck Configuration	As per which IRC Special Publication No. & Year	23	IRC SP 73-2015
	Footpath (Nil/One-side/Two-side)	24	Both side
	Kerb (Nil/One-side/Two-side)	25	Nil
	Crash Barrier {Number- Type (RCC/ W-Beam /Others)}	26	2 Nos RCC
	Railing (RCC/ Steel/Others)	27	One side Steel

<b>NORTHERN RAILWAY</b>				
	53	54	55	56
	9	10	11	12
1	SV-NR-CG-09	SV-NR-CG-10	SV-NR-CG-11	SV-NR-CG-12
2	-	-	-	CAO
3	-	-	-	-
4	L&T Infrastructure	L&T Infrastructure	L&T Infrastructure	G.R. Infra Project Ltd.
5	IIT Madras	IIT Madras	IIT Madras	IIT BHU
6	NRHQE Plan:ROB- 107/DLI / SH.01 Series	NRHQE Plan/ROB- 107/DLI (SH.11) Series	NRHQE Plan/ROB- 107/DLI (SH.11) Series	P-1828-RB/2020
7	Yes	Yes	Yes	Yes
8	No	No	No	Yes
9	Dec-20	Dec-20	Dec-20	Aug-20
10	Jan-21	Jan-21	Jan-21	Aug-20
11	Basai Dhankot Section LC NO 29 and 30 at Rly KM 37/3-4	Basai Dhankot Section LC No 29 And 30 at Rly KM 37/3-4	Basai Dhankot Section LC No 29 and 30 at Railway KM 37/3-4	Between Rly Stn Lohta and Choukhandi
12	Steel Composite Girder	Steel Composite Girder	Steel Composite Girder	Steel Composite Girder
13	36.056 to 37.04	42.226 to 47.007	42.226 to 47.007	43.8
14	2085	2125	2125	2507
15	4	4	6	6
16	IV	IV	IV	IV
17	51.342 to 52.513	52.51/52.406	52.51/52.406	0
18	0	0	0	0
19	9000	9000	11000	11500
20	2	2	3	3
21	One way	One way	One way	One way
22	10000	11000	14000	14500
23	-	-	-	-
24	Nil	Nil	One side	One side
25	Nil	Nil	Nil	Nil
26	Both side RCC	Both side RCC	Both side	2 Nos RCC Crash Barrier
27	Nil	Nil	One side	One side Steel

NORTHERN RAILWAY				
Sl. No.			57	58
Sub Sl. No.			13	14
Drawing Identification Code		1	SV-NR-BSG-01	SV-NR-CG-13
Designed by whom	Railway (CBE/CAO)	2	CAO	CAO
	PSU	3	-	-
Name of Consultant, if any	Design Consultant	4	Rice Pvt.Ltd	Almond Global Infra Consultant Ltd.
	Proof Consultant	5	IIT BHU	IIT Kanpur
Drawing Number		6	P-1959-RB/2020	P-1799-RB/2019
Whether Fit for Special Vehicle Loading of IRC-6:2017		7	Yes	Yes
Whether Designed with Congestion Factor		8	Yes	Yes
Month/Year of Design		9	Sep-21	Dec-20
Month Year of Approval of Design		10	Sep-21	Dec-20
Stations/Locations where used		11	Jalandhar-Pathankot	Between Rly Stn Kakori and Lucknow
Type of Superstructure		12	Bow String Girder	Steel Composite Girder
Span (m)		13	44.5	46.4
Depth of Girder including deck slab (mm)		14	1397	2415
Number of Girders in one span		15	1	6
Seismic Zone designed for		16	IV	III
Angle of Skew (Degrees)		17	0	0
Degree of curvature designed for		18	0	0
Carriageway Width (mm)		19	10500	11500
Number of lanes		20	2	3
Direction of road traffic		21	Two way	One way
Deck Width (mm)		22	15200	14500
Deck Configuration	As per which IRC Special Publication No. & Year	23	-	-
	Footpath (Nil/One-side/Two-side)	24	Both side	One side
	Kerb (Nil/One-side/Two-side)	25	Nil	Nil
	Crash Barrier {Number- Type (RCC/ W-Beam /Others)}	26	Both side RCC	Both side RCC
	Railing (RCC/Steel/Others )	27	Both side	One side Steel

<b>NORTHERN RAILWAY</b>				
	59	60	61	62
	15	16	17	18
1	SV-NR-BSG-02	SV-NR-BSG-03	SV-NR-BSG-04	SV-NR-BSG-05
2	CBE SPL	CAO	CAO	CAO
3	PWD Bhatinda	UPEIDA	-	-
4	-	B&S Engg Consultants Pvt. Ltd.	B&S Engineering Consultants Pvt. Ltd.	ASC Infra Pvt Ltd
5	MNAIT Bhopal	-	Dr. Dipti Ranjan Sahoo, IIT Delhi	IIT Delhi
6	P-1435-RB/2017	BSEC/1910/RO B-01/SD-101	P-1655-RB/2018	P-1656-RB/2018
7	Yes	Yes	Yes	Yes
8	No	Yes	Yes	Yes
9	Mar-18	-	Oct-19	May-19
10	Jul-18	Jun-20	Oct-19	May-19
11	Maur-Talwandi	Lko-Sln Section	Lucknow Sultanpur Section at Anoopganj Stn	Tulsinagar - Malipur
12	Bow String Girder	Bowstring Girder	Bowstring Girder	Bowstring Girder
13	48	50	50	56
14	1235	1638	1790	1745
15	1	1	1	1
16	III	III	III	IV
17	0	0	0	0
18	0	0	0	0
19	11000	16650	16650	16650
20	3	4	4	4
21	Two way	One way	One way	One way
22	12000	21250	21250	21250
23	-	-	-	-
24	Both side	Both Side	Both Side	Both side
25	Nil	Nil	Nil	Nil
26	Both side RCC	Both Side RCC	Both side RCC	Both side RCC
27	Both side	Both Side	Both side Steel	One side

<b>NORTHERN RAILWAY</b>				
Sl. No.			63	64
Sub Sl. No.			19	20
Drawing Identification Code		1	SV-NR-BSG-06	SV-NR-BSG-07
Designed by whom	Railway (CBE/CAO)	2	CAO	CAO
	PSU	3	-	-
Name of Consultant, if any	Design Consultant	4	B&S Engg Consultants Pvt. Ltd.	Asc Infratech Pvt Ltd
	Proof Consultant	5	IIT Delhi	Ascrcrte Consulting Pvt .Ltd. Gurgaon
Drawing Number		6	P-1658-RB/2018	P-1910-RB/2020
Whether Fit for Special Vehicle Loading of IRC-6:2017		7	Yes	Yes
Whether Designed with Congestion Factor		8	Yes	Yes
Month/Year of Design		9	Dec-19	Sep-21
Month Year of Approval of Design		10	Dec-19	Sep-21
Stations/Locations where used		11	Triveniganj And Haidergarh	Piparsand- Lucknow
Type of Superstructure		12	Bowstring Girder	Bowstring Girder
Span (m)		13	56	56
Depth of Girder including deck slab (mm)		14	1573	1714
Number of Girders in one span		15	1	1
Seismic Zone designed for		16	IV	III
Angle of Skew (Degrees)		17	0	0
Degree of curvature designed for		18	0	0
Carriageway Width (mm)		19	16650	11500
Number of lanes		20	4	3
Direction of road traffic		21	One way	One way
Deck Width (mm)		22	21550	14800
Deck Configuration	As per which IRC Special Publication No. & Year	23	-	-
	Footpath (Nil/One-side/Two-side)	24	Both side	One side
	Kerb (Nil/One-side/Two-side)	25	Nil	Nil
	Crash Barrier {Number- Type (RCC/W-Beam /Others)}	26	Both side RCC	Both Side RCC
	Railing (RCC/Steel/Others)	27	Both side	One side

<b>NORTHERN RAILWAY</b>				
	65	66	67	68
	21	22	23	24
1	SV-NR-BSG-08	SV-NR-BSG-09	SV-NR-BSG-10	SV-NR-BSG-11
2	CAO	CBE	CAO	CAO
3	UPEIDA	-	-	-
4	ASC Infratech Pvt Ltd	Structure Consultants Pvt Ltd	B&S Engineering Consultant Pvt Ltd	B&S Engineering Consultants Pvt. Ltd.
5	Transys Consultants Pvt Ltd	Jamia Milia Islamia	IIT Delhi	IIT Delhi
6	B011	P-1609-RB/2018	P-1657- RB/2018	P-1657-RB/2018
7	Yes	Yes	Yes	Yes
8	Yes	Yes	Yes	Yes
9	Nov-19	-	Nov-19	Nov-19
10	Jan-20	Feb-19	Nov-19	Nov-19
11	Faizabad-Jaunpur Section	SNL-ASR Section	Kurebhar And Dwarika Ganj	Between Rly Stn Kurebhar and Dwarikaganj
12	Bowstring Girder	Bow String Girder	Bowstring Girder	Bowstring Girder
13	56	62	62	62
14	1453	1335	1836	1836
15	1	1	1	Bowstring Girder
16	III	III	III	III
17	0	0	0	Straight
18	0	0	0	Straight
19	18450	10500	16650	16650
20	5	3	4	4
21	One way	One way	One way	One Way
22	20750	13000	21550	21550
23	-	-	-	-
24	One side	One side	Both side	Both side
25	Nil	Nil	Nil	Nil
26	Both side RCC	Both side RCC	Both side RCC	Both side RCC
27	One side Steel	One side Steel	One side Steel	One side Steel

<b>NORTHERN RAILWAY</b>				
Sl. No.			69	70
Sub Sl. No.			25	26
Drawing Identification Code		1	SV-NR-BSG-12	SV-NR-CG-14
Designed by whom	Railway (CBE/CAO)	2	CAO	CAO
	PSU	3	-	-
Name of Consultant, if any	Design Consultant	4	ASC Infratech Pvt Ltd	B&S Engineering Consultants Pvt. Ltd.
	Proof Consultant	5	IIT Bombay	IIT Delhi
Drawing Number		6	P-1911-RB/2020	P-1540-RB/2018
Whether Fit for Special Vehicle Loading of IRC-6:2017		7	Yes	Yes
Whether Designed with Congestion Factor		8	Yes	Yes
Month/Year of Design		9	Sep-21	Jun-20
Month Year of Approval of Design		10	Sep-21	Jul-20
Stations/Locations where used		11	Anoopganj And Bakkas	Between Rly Stn Maripat and Ghaziabad
Type of Superstructure		12	Bowstring Girder	Steel Composite Girder
Span (m)		13	62.01	62.373
Depth of Girder including deck slab (mm)		14	1727	3355
Number of Girders in one span		15	1	12
Seismic Zone designed for		16	III	IV
Angle of Skew (Degrees)		17	0	58.352°
Degree of curvature designed for		18	0	0
Carriageway Width (mm)		19	11500	9m+15m+2.5m (Cycling)
Number of lanes		20	3	2+4=6
Direction of road traffic		21	One way	One way
Deck Width (mm)		22	14800	30300
Deck Configuration	As per which IRC Special Publication No. & Year	23	-	-
	Footpath (Nil/One-side/Two-side)	24	One side	One Side
	Kerb (Nil/One-side/Two-side)	25	Nil	Nil
	Crash Barrier {Number- Type (RCC/ W-Beam /Others)}	26	Both side RCC	3 Nos RCC Crash Barrier
	Railing (RCC/Steel/Others)	27	One side	Steel



NORTHERN RAILWAY		
	71	72
	27	28
1	SV-NR-CG-15	SV-NR-BSG-13
2	CAO	CAO
3	-	-
4	B&S Engineering Consultants Pvt. Ltd.	AECOM India Pvt Ltd
5	IIT Delhi	IIT Delhi
6	P-1540-RB/2018	P-1682-RB/2019
7	Yes	Yes
8	Yes	Yes
9	Jun-20	May-19
10	Jun-20	May-19
11	Between Rly Stn Maripat and Ghaziabad	Sampla and Kharawar
12	Steel Composite Girder	Bowstring Girder
13	69.998	80
14	3550	1947
15	4	1
16	IV	IV
17	61.574°	0
18	0	0
19	9000	13000
20	2	3
21	One Way	One way
22	10000	16000
23	-	-
24	Nil	One side
25	Nil	Nil
26	2 Nos RCC Crash Barrier	2 Nos RCC Crash Barrier
27	Nil	One side

This page is left blank intentionally.

NORTH CENTRAL RAILWAY				
Sl. No.			73	74
Sub Sl. No.			1	2
Drawing Identification Code		1	SV-NCR-CG-01	SV-NCR-CG-02
Designed by whom	Railway (CBE/CAO)	2	-	-
	PSU	3	NHAI	
Name of Consultant, if any	Design Consultant	4	KCC Buildcon Pvt Limited	Transys Consulting Pvt Ltd
	Proof Consultant	5	IIT BHU	IIT Delhi
Drawing Number		6	KCCB/DV-5/STR/ROB/149+937/SS/ST_001	BE-II-74+966, 807-ROB-306
Whether Fit for Special Vehicle Loading of IRC-6:2017		7	Yes	Yes
Whether Designed with Congestion Factor		8	-	-
Month/Year of Design		9	Jan-20	Feb-21
Month Year of Approval of Design		10	Mar-21	Feb-21
Stations/Locations where used		11	Near Junction of SH44 to Delhi Vadodra Greenfield Alignment Rajasthan	Mahokhar To Kaohari Uttat Pradesh
Type of Superstructure		12	Steel Composite Girder	Steel Composite Girder
Span (m)		13	36	36
Depth of Girder including deck slab (mm)		14	1831	1831
Number of Girders in one span		15	9	7
Seismic Zone designed for		16	III	III
Angle of Skew (Degrees)		17	30	20
Degree of curvature designed for		18	0	0
Carriageway Width (mm)		19	20250	12650
Number of lanes		20	4	3
Direction of road traffic		21	One way	One way
Deck Width (mm)		22	21250	17400
Deck Configuration	As per which IRC Special Publication No. & Year	23	-	-
	Footpath (Nil/One-side/Two-side)	24	Nil	One side
	Kerb (Nil/One-side/Two-side)	25	Nil	One side
	Crash Barrier {Number- Type (RCC/ W-Beam /Others)}	26	Both side RCC	Both side RCC
	Railing (RCC/Steel/Others)	27	Nil	One side

<b>NORTHEAST FRONTIER RAILWAY</b>				
Sl. No.			75	76
Sub Sl. No.			1	2
Drawing Identification Code		1	SV-NFR-CG-01	SV-NFR-CG-02
Designed by whom	Railway (CBE/CAO)	2	CBE	CBE
	PSU	3	NHAI	-
Name of Consultant, if any	Design Consultant	4	Asabz Infra Sollutions	Credence Imagineering
	Proof Consultant	5	IIT BHU	IIT Delhi
Drawing Number		6	ROB/B/49/2017	ROB/B/6/1/2019
Whether Fit for Special Vehicle Loading of IRC-6:2017		7	Yes	Yes
Whether Designed with Congestion Factor		8	No	No
Month/Year of Design		9	Feb-21	Mar-19
Month Year of Approval of Design		10	Apr-21	Mar-19
Stations/Locations where used		11	Katihar-Jogabani	Oodlabari-Damdim
Type of Superstructure		12	Composite steel girder	Composite steel girder
Span (m)		13	37.2	41.0
Depth of Girder including deck slab (mm)		14	2250	2297
Number of Girders in one span		15	5	5
Seismic Zone designed for		16	IV	IV
Angle of Skew (Degrees)		17	32.49	8.2
Degree of curvature designed for		18	0	0
Carriageway Width (mm)		19	9500	9500
Number of lanes		20	2	2
Direction of road traffic		21	Two way	One way
Deck Width (mm)		22	12500	12500
Deck Configuration	As per which IRC Special Publication No. & Year	23	-	-
	Footpath (Nil/One-side/Two-side)	24	Nil	One side
	Kerb (Nil/One-side/Two-side)	25	Both side	One side
	Crash Barrier {Number- Type (RCC/ W-Beam /Others)}	26	Both Side RCC	Both Side RCC
	Railing (RCC/Steel/ Others)	27	Nil	One side RCC

<b>NORTHEAST FRONTIER RAILWAY</b>		
	77	78
	3	4
1	SV-NFR-BSG-01	SV-NFR-BSG-02
2	CBE	CBE
3	NHAI	PWD
4	Transys Cunsultants Pvt Ltd	EIS Planners & Engineers
5	IIT Mumbai	IIT Guwahati
6	ROB/B/14/1/2020	ROB/B/03/2020 series
7	Yes	Yes
8	No	No
9	-	Jan-20
10	Nov-20	Jun-20
11	Raiganj-Dalkhola section of NH-34	Jorhat Town
12	Bow String Girder	Bow String Girder
13	49.2	62.0
14	1353	1231
15	One	One
16	V	IV
17	0	0
18	0	0
19	13000	10500
20	3	2
21	One way	Two way
22	15800	11400
23	-	-
24	One side	Both side
25	Nil	Nil
26	Both side RCC	Both side RCC
27	Steel	Both side Steel

<b>NORTH WESTERN RAILWAY</b>				
Sl. No.			79	80
Sub Sl. No.			1	2
Drawing Identification Code		1	SV-NWR-CG-01	SV-NWR-CG-02
Designed by whom	Railway (CBE/CAO)	2	CBE	CBE
	PSU	3	NHAI	NHAI
Name of Consultant, if any	Design Consultant	4	G Eng.Advisory Services	AECOM India
	Proof Consultant	5	IIT Delhi	IIT Delhi
Drawing Number		6	CBE-1182/BKN/ROB/2020	CBE-1171/BKN/ROB/2020
Whether Fit for Special Vehicle Loading of IRC-6:2017		7	Yes	Yes
Whether Designed with Congestion Factor		8	No	No
Month/Year of Design		9	Aug.2020	Jul-20
Month Year of Approval of Design		10	Nov. 2020	Oct.2020
Stations/Locations where used		11	Kalanpur kalan-Khrak	Guru kalan-Bhojiyawas
Type of Superstructure		12	Composite Steel Girder	Composite Steel Girder
Span (m)		13	24	24
Depth of Girder including deck slab (mm)		14	1520	1881
Number of Girders in one span		15	6	6
Seismic Zone designed for		16	IV	IV
Angle of Skew (Degrees)		17	0	20
Degree of curvature designed for		18	0	0
Carriageway Width (mm)		19	13500	13500
Number of lanes		20	3	3
Direction of road traffic		21	One way	One way
Deck Width (mm)		22	14500	14500
Deck Configuration	As per which IRC Special Publication No. & Year	23	-	-
	Footpath (Nil/One-side/Two-side)	24	Nil	Nil
	Kerb (Nil/One-side/Two-side)	25	Nil	Nil
	Crash Barrier {Number- Type (RCC/ W-Beam /Others)}	26	Both side RCC	Both side RCC
	Railing (RCC/ Steel/Others)	27	Nil	Nil

<b>NORTH WESTERN RAILWAY</b>				
	81	82	83	84
	3	4	5	6
1	SV-NWR-CG-03	SV-NWR-CG-04	SV-NWR-CG-05	SV-NWR-CG-06
2	CBE	CAO	CAO	CAO
3	NHAI	-	-	-
4	Tech Tangant Solution	Jindal Consortium	Multi Media Construction Pvt.Ltd	Multi Media Construction Pvt.Ltd
5	MNIT Jaipur	IIT Roorkee	SVNIT Surat	SVNIT Surat
6	CBE-1154/JU/ROB/2020	CAO/C/JP 8025 TO 8030/D-ROB	CAO/C/JP/811&8112/8141/D-UDZ-HMT.	CAO/C/JP/8101 TO 8103/D-UDZ-HMT
7	Yes	Yes	Yes	Yes
8	No	No	No	No
9	Mar-20	Jul-21	Aug-21	Aug-21
10	Aug.2020	Jul-21	Aug-21	Sep-21
11	Osian-Bhimkor	Rewari-Ringas (CH:3.3255)	Raighadh Road & Viravada	Shamla JI Road & Raighadh Road (CH:286/3-4)
12	Composite steel girder	Composite steel girder	Composite steel girder	Composite steel girder
13	30	30.533	32.25	36
14	1625	1775	2435	1840
15	7	12	6	6
16	III	III	III	III
17	14.24	5.57	55	35
18	0	0	0	0
19	13500	13000	10500	10500
20	3	3	3	3
21	One way	One way	One way	One way
22	16500	15700	15300	15300
23	-	-	IRC 87-2013	IRC 87-2013
24	One side	One side	One side	One side
25	Nil	One side	Both side	Both side
26	Both side RCC	Both side RCC	Both side RCC	Both side RCC
27	One side	One side	One side	One side

NORTH WESTERN RAILWAY				
Sl. No.			85	86
Sub Sl. No.			7	8
Drawing Identification Code		1	SV-NWR-CG-07	SV-NWR-CG-08
Designed by whom	Railway (CBE/CAO)	2	CBE	CBE
	PSU	3	NHAI	NHAI
Name of Consultant, if any	Design Consultant	4	Force Structural Engineers Mumbai	Tech Tangent Solution Pvt Ltd
	Proof Consultant	5	IIT Mumbai	MNIT Jaipur
Drawing Number		6	CBE-1241/JP/ROB/2021	CBE-1234/JU/ROB/2021
Whether Fit for Special Vehicle Loading of IRC-6:2017		7	Yes	Yes
Whether Designed with Congestion Factor		8	No	No
Month/Year of Design		9	Jan. 2021	Sep.2020
Month Year of Approval of Design		10	Aug. 2021	July. 2021
Stations/Locations where used		11	Sawaimadhampur-Devepur	Jamiyana- Balotra
Type of Superstructure		12	Composite Steel Girder	Composite Steel Girder
Span (m)		13	36	36
Depth of Girder including deck slab (mm)		14	1881	1881
Number of Girders in one span		15	8	7
Seismic Zone designed for		16	II	III
Angle of Skew (Degrees)		17	16.9	17.76
Degree of curvature designed for		18	0	0
Carriageway Width (mm)		19	20250	13500
Number of lanes		20	4	3
Direction of road traffic		21	One way	One way
Deck Width (mm)		22	21250	16500
Deck Configuration	As per which IRC Special Publication No. & Year	23	-	-
	Footpath (Nil/One-side/Two-side)	24	Nil	One side
	Kerb (Nil/One-side/Two-side)	25	Nil	nil
	Crash Barrier {Number- Type (RCC/ W-Beam /Others)}	26	Both side RCC	Both side RCC
	Railing (RCC/ Steel/Others)	27	Nil	One side



<b>NORTH WESTERN RAILWAY</b>			
	87	88	89
	9	10	11
1	SV-NWR-CG-09	SV-NWR-CG-10	SV-NWR-CG-11
2	CAO	CAO	CBE
3	-	- -	NHAI
4	BPS Engineering	Dhabai Construction, Siker	Accrete Consulting Eng.
5	TTL Engineering	-	IIT-BHU
6	CAO/C/JP/7895 TO 7901/D-ROB/DO-GGC	CAO/C/JP/7971 TO 7974/DFL-SBR-ROB-01	CBE- 1233/JU/ROB/2021
7	Yes	Yes	Yes
8	No	No	No
9	Apr-21	Apr-21	Jun-20
10	Apr-21	Jun-21	Jul-21
11	DAUSA (NH 11A)	FL-SBR(CH:1/3-4)	Dehmok- Surpura
12	Composite Steel Girder	Composite Steel Girder	Composite Steel Girder
13	43.3	43.72	50
14	2750	2250	1545
15	9	5	6
16	II	II	III
17	50.138	0	0
18	0	0	0
19	20250	10000	13500
20	4	2	3
21	One way	One way	One way
22	21250	12500	16300
23	-	-	-
24	Nil	One side	One side
25	Nil	Nil	One
26	Both side RCC	Both side RCC	Both side RCC
27	Nil	One side	One side

<b>SOUTHERN RAILWAY</b>				
Sl. No.			90	91
Sub Sl. No.			1	2
Drawing Identification Code		1	SV-SR-CG-01	SV-SR-CG-02
Designed by whom	Railway (CBE/CAO)	2	CBE	CBE
	PSU	3	NHAI	NHAI
Name of Consultant, if any	Design Consultant	4	Force Structural Engineers Pvt Ltd	Force Structural Engineers Pvt Ltd
	Proof Consultant	5	IIT Mumbai	IIT Mumbai
Drawing Number		6	CBE/GV2/141/2017	CBE/GV2/141/2017
Whether Fit for Special Vehicle Loading of IRC-6:2017		7	Yes	Yes
Whether Designed with Congestion Factor		8	No	No
Month/Year of Design		9	Nov-17	Nov-17
Month Year of Approval of Design		10	Aug-18	Aug-18
Stations/Locations where used		11	Nagercoil- Tovalai Station	Nagercoil- Tovalai Station
Type of Superstructure		12	Composite Steel Girder	Composite Steel Girder
Span (m)		13	15.58	18.471
Depth of Girder including deck slab (mm)		14	1469	1469
Number of Girders in one span		15	5	5
Seismic Zone designed for		16	II	II
Angle of Skew (Degrees)		17	13	13
Degree of curvature designed for		18	0	0
Carriageway Width (mm)		19	11000	11000
Number of lanes		20	3	3
Direction of road traffic		21	One way	One way
Deck Width (mm)		22	13750	13750
Deck Configuration	As per which IRC Special Publication No. & Year	23	-	-
	Footpath (Nil/One-side/Two-side)	24	One side	One side
	Kerb (Nil/One-side/Two-side)	25	Nil	Nil
	Crash Barrier {Number- Type (RCC/ W-Beam /Others)}	26	Both side / RCC	Both side / RCC
	Railing (RCC/Steel/Others )	27	RCC	RCC

**SOUTHERN RAILWAY**

	92
	3
1	SV-SR-CG-03
2	CBE
3	NHAI
4	Louis Berger
5	IIT Delhi
6	CBE/GT2/207/2017
7	Yes
8	No
9	Dec-20
10	Oct-21
11	Sillakkudi- Kallagam
12	Composite Steel Girder
13	53
14	2850
15	6
16	II
17	15
18	0
19	12000
20	3
21	One way
22	16000
23	-
24	One side
25	Both side
26	Both side / RCC
27	RCC

<b>SOUTH CENTRAL RAILWAY</b>				
Sl. No.		93	94	
Sub Sl. No.		1	2	
Drawing Identification Code	1	SV-SCR-CG-01	SV-SCR-CG-02	
Designed by whom	Railway (CBE/CAO)	2	CBE	CBE
	PSU	3	NHAI	APRDC
Name of Consultant, if any	Design Consultant	4	L&T Infrastructure Engineering Ltd	Sheladia Associates INC,USA
	Proof Consultant	5	IIT Madras	IIT Madras
Drawing Number	6	GM(W)SC/Br/R-207/2018 to GM(W)SC/Br/R-216/2018	GM(W)SC/Br/R-57/2014 to GM(W)SC/Br/R-63/2014	
Whether Fit for Special Vehicle Loading of IRC-6:2017	7	Yes	Yes	
Whether Designed with Congestion Factor	8	Yes	Yes	
Month/Year of Design	9	Aug-17	Aug-2014	
Month Year of Approval of Design	10	Dec-18	Dec.-2014	
Stations/Locations where used	11	Allur Road - Bitragunta	Narasaraopet-Vinukonda	
Type of Superstructure	12	Composite Steel girder	Composite steel girder	
Span (m)	13	28.646	35.008	
Depth of Girder including deck slab (mm)	14	2375	2600	
Number of Girders in one span	15	7	6	
Seismic Zone designed for	16	III	II	
Angle of Skew (Degrees)	17	51.66	44.37°	
Degree of curvature designed for	18	0	0	
Carriageway Width (mm)	19	12175	10750	
Number of lanes	20	3	3	
Direction of road traffic	21	One way	One way	
Deck Width (mm)	22	15000	13750	
Deck Configuration	As per which IRC Special Publication No. & Year	23	-	-
	Footpath (Nil/One-side/Two-side)	24	One side	One side
	Kerb (Nil/One-side/Two-side)	25	Nil	Nil
	Crash Barrier {Number- Type (RCC/ W-Beam /Others)}	26	Both side / RCC	Both side
	Railing (RCC/Steel/Others)	27	One side RCC Parapet	One side RCC Parapet

<b>SOUTH CENTRAL RAILWAY</b>				
	95	96	97	98
	3	4	5	6
1	SV-SCR-CG-03	SV-SCR-CG-04	SV-SCR-CG-05	SV-SCR-CG-06
2	CBE	CBE	CAO	CBE
3	MSRDC	APRDC	-	Aurangabad Industrial Township Ltd.
4	B&S Engineering Consultants Pvt. Ltd.	Sheladia Associates INC, USA	-	ACME Structural Consultants, Pune
5	IIT Delhi	IIT Madras	-	IIT Bombay
6	GM(W)SC/BR/R-157 to 166/2021	GM(W)SC/Br/R-12/2014 to GM(W)SC/Br/R-16/2014	CAO/C/D/ST/552-2019 to CAO/C/D/ST/559-2019	GM(W)SC/Br/R-3/2018 to GM(W)SC/Br/R-11/2018
7	Yes	Yes	Yes	Yes
8	Yes	Yes	No	Yes
9	Oct-20	Aug-2014	Apr-19	Nov.-2017
10	Sep-21	Oct-2014	Nov-19	Jan.-2018
11	Amanwadi - Jaulka	Bellamkonda-Piduguralla	Bayyavaram and Anakapalli Stations	Karmad-Chikalhana
12	Composite steel Girder	Composite Steel Girder	Composite Steel Girder	Composite steel Girder
13	36	36.69	38.47	40.3
14	1831	2600	-	2722
15	7	6	5	6
16	II	II	3	II
17	0	41°	0	11°
18	0	0	0	0
19	14750	10750	7750	11500
20	3	3	2	3
21	One way	One way	Two way	One way
22	17550	13750	13000	14450
23	-	-	-	-
24	One side	One side	Two sided	One side
25	Nil	Nil	Nil	Nil
26	Two RCC	Two RCC	Two RCC	Two RCC
27	One side RCC Parapet	Two side RCC Parapet	Two side RCC Parapet	One side RCC Parapet

<b>SOUTH CENTRAL RAILWAY</b>				
Sl. No.			99	100
Sub Sl. No.			7	8
Drawing Identification Code		1	SV-SCR-CG-07	SV-SCR-BSG-01
Designed by whom	Railway (CBE/CAO)	2	CBE	CAO
	PSU	3	R&B Dept, Telangana	-
Name of Consultant, if any	Design Consultant	4	Pragathi Consultants, Hyderabad	Spera Infra Consultant
	Proof Consultant	5	-	IIT Hyderabad
Drawing Number		6	GM(W)SC/Br/R-50 to 54, 64, 66 & 69/2018	CAO/C/D/ST/391-2021 series
Whether Fit for Special Vehicle Loading of IRC-6:2017		7	Yes	Yes
Whether Designed with Congestion Factor		8	Yes	No
Month/Year of Design		9	11-2016	Feb-21
Month Year of Approval of Design		10	04-2018	Aug-21
Stations/Locations where used		11	Ramgundam - Raghavapuram	Manoharabad and Gajwvel station
Type of Superstructure		12	Composite steel girder	Bow String Girder
Span (m)		13	42	42
Depth of Girder including deck slab (mm)		14	3164	1010
Number of Girders in one span		15	6	1
Seismic Zone designed for		16	II	II
Angle of Skew (Degrees)		17	0	0
Degree of curvature designed for		18	0	0
Carriageway Width (mm)		19	11000	11000
Number of lanes		20	3	3
Direction of road traffic		21	One way	One way
Deck Width (mm)		22	13750	12050
Deck Configuration	As per which IRC Special Publication No. & Year	23	-	-
	Footpath (Nil/One-side/Two-side)	24	One side	Nil
	Kerb (Nil/One-side/Two-side)	25	Nil	Nil
	Crash Barrier {Number- Type (RCC/ W-Beam /Others)}	26	Two RCC	Two RCC
	Railing (RCC/ Steel /Others)	27	One side RCC Parapet	Nil

<b>SOUTH CENTRAL RAILWAY</b>				
	101	102	103	104
	9	10	11	12
1	SV-SCR-CG-08	SV-SCR-CG-09	SV-SCR-CG-10	SV-SCR-CG-11
2	CAO	CBE	CBE	CAO
3	-	MSRDC	Prime Rail Infra	-
4	Srinivasa Constructions	Gravitas Infrastructures Pvt. Ltd., Lucknow	IIT Mumbai	SMR Consultants
5	JNTU Hyderabad	IIT Bombay	IIT Mumbai	NIT Warangal
6	CAO/C/D/ST/75 -2020 to CAO/C /D/ST/77-2020 and RDSO /B- 11758/5R	GRA/DWG/10 1 to 106 AND GRA/DWG/10 8 to 112	PRI-STR-DWG- 2281	CAO/C/D/RC/12 4-2020 to CAO/C/D/RC/13 4-2020
7	Yes	Yes	Yes	Yes
8	Yes	Yes	Yes	No
9	Aug-19	Feb-20	Feb-19	Sep-19
10	Jan-20	Mar-20	Feb-19	Feb-20
11	Hafizpeta and Sanathnagar	Lasur- Karanjgaon	Chittor & RVS Nagar	Mellacheruvu and Revuru Ramapuram Stations
12	Composite steel girder	Composite steel girder	Composite steel girder	Composite steel girder
13	44.5	44.5	44.5	44.5
14	4350	2559	2511	2770
15	5	8	6	6
16	II	II	III	2
17	0	19.97	0	20
18	0	0	0	0
19	7500	16500	8500	10500
20	2	4	2	2
21	One way	One way	One way	Two way
22	10055	19500	12500	14800
23	-	-	-	-
24	One	One side	One side	Two sided
25	Nil	Nil	Both side	Nil
26	Two RCC	Two RCC	Both side	Two-RCC
27	RCC Parapet	One side RCC Parapet	One side RCC Parapet	Two side RCC Parapet

<b>SOUTH CENTRAL RAILWAY</b>				
Sl. No.			105	106
Sub Sl. No.			13	14
Drawing Identification Code		1	SV-SCR-CG-12	SV-SCR-CG-13
Designed by whom	Railway (CBE/CAO)	2	CBE	CBE
	PSU	3	MORTH	IPRCL
Name of Consultant, if any	Design Consultant	4	Neel Construction Links Pvt. Ltd., Gurgram	Primerail Infralabs Pvt Ltd
	Proof Consultant	5	IIT Delhi	IIT Madras
Drawing Number		6	GM(W)SC/Br/R-32/2021 to GM(W)SC/Br/R-42/2021	GM(W)SC/Br/R-77/2020 to GM(W)SC/Br/R-88/2020
Whether Fit for Special Vehicle Loading of IRC-6:2017		7	Yes	Yes
Whether Designed with Congestion Factor		8	Yes	Yes
Month/Year of Design		9	Jan-20	01-2020
Month Year of Approval of Design		10	Feb-21	08-2020
Stations/Locations where used		11	Cherukuwada - Undi	Akiveedu - Pallevada
Type of Superstructure		12	Composite steel girder	Composite steel girder
Span (m)		13	44.5	44.5
Depth of Girder including deck slab (mm)		14	2557	2519
Number of Girders in one span		15	6	6
Seismic Zone designed for		16	III	III
Angle of Skew (Degrees)		17	20	20°
Degree of curvature designed for		18	0	0
Carriageway Width (mm)		19	11000	8500
Number of lanes		20	2	2
Direction of road traffic		21	Two way	One way
Deck Width (mm)		22	16000	12500
Deck Configuration	As per which IRC Special Publication No. & Year	23	-	-
	Footpath (Nil/One-side/Two-side)	24	Two sided	One side
	Kerb (Nil/One-side/Two-side)	25	Nil	Both side
	Crash Barrier {Number- Type (RCC/ W-Beam /Others)}	26	Two-RCC	Two-RCC
	Railing (RCC/Steel/Others)	27	Both side Steel	One side RCC Parapet



<b>SOUTH CENTRAL RAILWAY</b>				
	107	108	109	110
	15	16	17	18
1	SV-SCR-CG-14	SV-SCR-CG-15	SV-SCR-CG-16	SV-SCR-CG-17
2	CBE	CBE	CBE	CBE
3	NHAI	NHAI	NHAI	NHAI
4	L&T Infrastructure Engineering Ltd.	Accrete Consulting Engineers	Dilip Buildcon Limited	HBS Infra Engineers India
5	IIT Madras	IIT-BHU	IIT BHU	IIT BHU
6	GM(W)SC/Br/R-12/2015 to GM(W)SC/Br/R-20/2015	1099/GUN-KOV/NH-16/ST/ROB/18+677.385/312 to 322 & 402	18130-RB-PS-GA-7311 Series	HBS/GI-IV/SE/ROB-246.572/SUPC/004
7	Yes	Yes	Yes	Yes
8	Yes	Yes	No	No
9	01-2015	Aug-19	Sep-19	Oct-19
10	02-2015	Sep-19	Jun-19	Jan-20
11	Muddanur-Mangapatnam	Denduluru-Bhimadolu	Anakapalli - Anandapuram Section in NH -16 in A.P.	Giddalur - Vinukonda Section of NH-544D
12	Composite steel girder	Composite steel girder	Composite steel girder	Composite steel girder
13	44.5	45.79	46	46
14	3157	2519	2722	2511
15	6	8	6	6
16	II	III	II	III
17	20°	20	18.704	20
18	0	0	0	0
19	9500	13000	13500	11500
20	2	3	4	2
21	One way	One way	One way	Two way
22	12900	16000	14500	12500
23	-	-	-	-
24	Nil	One side	Nil	Nil
25	Nil	Nil	Nil	Nil
26	Two-RCC	Two-RCC	Both side	Both side
27	Nil	RCC Parapet	Nil	Nil

<b>SOUTH CENTRAL RAILWAY</b>				
Sl. No.			111	112
Sub Sl. No.			19	20
Drawing Identification Code		1	SV-SCR-CG-18	SV-SCR-CG-19
Designed by whom	Railway (CBE/CAO)	2	CBE	CBE
	PSU	3	NHAI	MRIDCL
Name of Consultant, if any	Design Consultant	4	Accrete Consulting Engineers	MRIDCL
	Proof Consultant	5	IIT BHU	IIT, Bombay
Drawing Number		6	1099/GUN-KOV/NH-16/ST/ROB/18+677.385 Series	GM(W)SC/Br/R-139 to 147&156 to 164/2020
Whether Fit for Special Vehicle Loading of IRC-6:2017		7	Yes	Yes
Whether Designed with Congestion Factor		8	No	Yes
Month/Year of Design		9	Mar-19	12-2019
Month Year of Approval of Design		10	Sep-19	11-2020
Stations/Locations where used		11	Gundugolanu - Devarapalli-Kovvuru Section of NH-16 In A.P.	Chawda-Purna-Marsul
Type of Superstructure		12	Composite steel girder	Composite steel girder
Span (m)		13	47.092	51.15
Depth of Girder including deck slab (mm)		14	2511	2750
Number of Girders in one span		15	8	8
Seismic Zone designed for		16	III	II
Angle of Skew (Degrees)		17	20	0
Degree of curvature designed for		18	0	0
Carriageway Width (mm)		19	15000	13000
Number of lanes		20	4	3
Direction of road traffic		21	One way	Two way
Deck Width (mm)		22	16000	18000
Deck Configuration	As per which IRC Special Publication No. & Year	23	-	-
	Footpath (Nil/One-side/Two-side)	24	Nil	Two side
	Kerb (Nil/One-side/Two-side)	25	Nil	Nil
	Crash Barrier {Number- Type (RCC/ W-Beam /Others)}	26	Both side	Two RCC
	Railing (RCC/Steel/Others)	27	Nil	Two side steel

<b>SOUTH CENTRAL RAILWAY</b>			
	113	114	115
	21	22	23
1	SV-SCR-CG-20	SV-SCR-CG-21	SV-SCR-CG-22
2	CBE	CAO	CBE
3	PWD, Govt of Maharashtra	-	Tirupati Smart City Corporation Ltd.
4	L&T Construction Infrastructure	SMR Consultants	Force Structural Engineers Pvt Ltd
5	IIT Bombay	-	IIT Bombay
6	GM(W)SC/Br/R-87/2018 to 93/2018 & 103/2018	CAO/C/D/RC/008-2018 to CAO/C/D/RC/13-2018	GM(W)SC/Br/R-63/2021 to GM(W)SC/Br/R-71/2021
7	Yes	Yes	Yes
8	Yes	No	Yes
9	05-2018	Jun-17	09-2020
10	01-2018	Jan-18	04-2021
11	Manwath (Tadborgaon) section	Kurnool city and Dhupadu stations	Tiruchanur-Tirpuati
12	Composite steel girder	Composite steel girder	Composite steel girder
13	56.16	57.8	58
14	3395	2730	3613
15	7	6	6
16	II	2	II
17	20°	0	0
18	0	0	0
19	10500	7500	15600
20	3	2	4
21	One way	Two way	Two way
22	14800	12000	16600
23	-	-	-
24	Two side	Two side	Nil
25	Nil	Nil	Nil
26	Two RCC	Two RCC	Two RCC
27	Two side steel	Both side RCC Parapet	Nil

<b>SOUTH WESTERN RAILWAY</b>				
Sl. No.			116	117
Sub Sl. No.			1	2
Drawing Identification Code		1	SV-SWR-BSG-01	SV-SWR-BSG-02
Designed by whom	Railway (CBE/CAO)	2	CBE	CBE
	PSU	3	NHAI	NHAI
Name of Consultant, if any	Design Consultant	4	Samarth Infraengg. Pvt Ltd	LEA Associates
	Proof Consultant	5	IIT Madras	IIT Madras
Drawing Number		6	SWR/2019/STR-15/ROB	SWR/2020/STR-28/ROB-65.0/CHKE-BAHI/JRU-RDG/NHAI
Whether Fit for Special Vehicle Loading of IRC-6:2017		7	Yes	Yes
Whether Designed with Congestion Factor		8	No	No
Month/Year of Design		9	-	-
Month Year of Approval of Design		10	May-19	2020
Stations/Locations where used		11	Arsikere(Ask)-Birur(Rrb) Section	Chkebahi To Bahi
Type of Superstructure		12	Bow string girder	Bow string girder
Span (m)		13	48.0	72.0
Depth of Girder including deck slab (mm)		14	1505	1445
Number of Girders in one span		15	One	One
Seismic Zone designed for		16	II	II
Angle of Skew (Degrees)		17	0	0
Degree of curvature designed for		18	0	0
Carriageway Width (mm)		19	12000	13000
Number of lanes		20	3	3
Direction of road traffic		21	One way	One way
Deck Width (mm)		22	16000	16000
Deck Configuration	As per which IRC Special Publication No. & Year	23	-	-
	Footpath (Nil/One-side/Two-side)	24	One side	One side
	Kerb (Nil/One-side/Two-side)	25	Nil	Nil
	Crash Barrier {Number- Type (RCC/ W-Beam /Others)}	26	Two RCC	Two RCC
	Railing (RCC/Steel/Others)	27	One Steel	One Steel

WESTERN RAILWAY				
Sl. No.			118	119
Sub Sl. No.			1	2
Drawing Identification Code		1	SV-WR-CG-01	SV-WR-CG-02
Designed by whom	Railway (CBE/CAO)	2	CBE	CBE
	PSU	3	-	-
Name of Consultant, if any	Design Consultant	4	GR Infraprojects	STUP Consultants Pvt. Ltd Mumbai
	Proof Consultant	5	IIT BHU	IIT Mumbai
Drawing Number		6	GR/KAKA/STR/RO B/304	7618/E/DD-552
Whether Fit for Special Vehicle Loading of IRC-6:2017		7	Yes	Yes
Whether Designed with Congestion Factor		8	No	No
Month/Year of Design		9	Dec-20	Dec-20
Month Year of Approval of Design		10	Dec-20	Dec-20
Stations/Locations where used		11	BRLA-NLI/KM.351-4-8	NARODA-DABHODA /KM.399/5-6 (LC-9)
Type of Superstructure		12	Composite steel girder	Composite steel girder
Span (m)		13	32.6	36
Depth of Girder including deck slab (mm)		14	1677	2095
Number of Girders in one span		15	7	6
Seismic Zone designed for		16	III	III
Angle of Skew (Degrees)		17	58	45
Degree of curvature designed for		18	0	0
Carriageway Width (mm)		19	20250	11250
Number of lanes		20	6	3
Direction of road traffic		21	One way	One way
Deck Width (mm)		22	21250	14300
Deck Configuration	As per which IRC Special Publication No. & Year	23	-	-
	Footpath (Nil/One-side/Two-side)	24	0	One side
	Kerb (Nil/One-side/Two-side)	25	Nil	One
	Crash Barrier {Number- Type (RCC/ W-Beam /Others)}	26	Both side RCC	Both side RCC
	Railing (RCC/Steel/Others)	27	Nil	One side

<b>WEST CENTRAL RAILWAY</b>				
Sl. No.			120	121
Sub Sl. No.			1	2
Drawing Identification Code		1	SV-WCR-CG-01	SV-WCR-CG-02
Designed by whom	Railway (CBE/CAO)	2	CBE	CBE
	PSU	3	-	-
Name of Consultant, if any	Design Consultant	4	Tranzroad Consulting Engineering Pvt Ltd.	L&T Infrastructre Engineering Ltd
	Proof Consultant	5	Jain Narayan Vyas University	IIT Chennai
Drawing Number		6	HQ DRG No. GM(W) 5569-5576 & 5585-5595	HQ DRG No. GM(W) 5528-5543
Whether Fit for Special Vehicle Loading of IRC-6:2017		7	Yes	Yes
Whether Designed with Congestion Factor		8	Yes	Yes
Month/Year of Design		9	11/2021.	12/2020.
Month Year of Approval of Design		10	12/2021.	11/2021.
Stations/Locations where used		11	LC-18 Sagar-Bina	Km 997/9-11 Nagda-Mathura
Type of Superstructure		12	Composite Steel Girder	Composite Steel Girder
Span (m)		13	36.79	51
Depth of Girder including deck slab (mm)		14	1581	2250
Number of Girders in one span		15	6	8
Seismic Zone designed for		16	III	II
Angle of Skew (Degrees)		17	22.8	45
Degree of curvature designed for		18	0	0
Carriageway Width (mm)		19	11000	20250
Number of lanes		20	2	6
Direction of road traffic		21	Two way	One way
Deck Width (mm)		22	15600	21250
Deck Configuration	As per which IRC Special Publication No. & Year	23	-	-
	Footpath (Nil/One-side/Two-side)	24	Yes - Both side	No
	Kerb (Nil/One-side/Two-side)	25	No	No
	Crash Barrier {Number- Type (RCC/ W-Beam /Others)}	26	RCC-Both side	RCC-Both side
	Railing (RCC/ Steel/Others)	27	RCC-Both side	No

**Chapter IV**  
**List of Drawings for other than Special Vehicle  
Loading**

This page is left blank intentionally.



**List of RDSO Drawings for other than Special Vehicle Loading**

### List of RDSO Standard Drawings of Composite Plate Girders

List of RDSO Standard Drawings of Composite Plate Girders								
Sl. No.			1					
Sub Sl. No.			1					
Drawing Identification No.		1	RDSO/B-11756					
Whether Fit for SV Loading		2	No					
Designed with Congestion Factor		3	No					
Month/ Year of Design		4	04/2013					
Month/ Year of Approval		5	04/2013					
Span (m)		6	18					
Depth of Girder (mm)		7	1154					
Seismic Zone designed for		8	V					
Angle of Skew designed for		9	Upto 20					
Degree of curvature designed for		10	Upto 10					
Number of Girders in one span		11	4	4	5	5	6	6
Carriageway Width (mm)		12	7500	7500	7500	10500	10500	10500
Number of lanes		13	2	2	2	3	3	2
Direction of road traffic		14	One way	One way	One way	One way	One way	Two way
Deck Width (mm)		15	9900	10100	11800	12900	13400	14800
Deck Configuration	As per which IRC Special Publication No. & Year	16	Nil	Nil	Nil	Nil	Nil	Nil
	Footpath (Nil/One-side/Two-side)	17	Nil	One side	Both side	Nil	One side	Both side
	Kerb (Nil/One-side/Two-side)	18	Both side	Nil	Nil	Both side	Nil	Nil
	Crash Barrier {Number-Type (RCC/ W-Beam /Others)}	19	Both side RCC	Both side RCC	Both side RCC	Both side RCC	Both side RCC	Both side RCC
	Railing (RCC/Steel/ Others)	20	Nil	One side Steel	Both side Steel	Nil	One side Steel	Both side Steel

### List of RDSO Standard Drawings of Composite Plate Girders

Sl. No.		2						
Sub Sl. No.		2						
Drawing Identification No.	1	RDSO/B-11757						
Whether Fit for SV Loading	2	No						
Designed with Congestion Factor	3	No						
Month/ Year of Design	4	03/2013						
Month/ Year of Approval	5	03/2013						
Span (m)	6	24						
Depth of Girder (mm)	7	1564						
Seismic Zone designed for	8	V						
Angle of Skew designed for	9	Upto 20						
Degree of curvature designed for	10	Upto 10						
Number of Girders in one span	11	4	4	5	5	6	6	
Carriageway Width (mm)	12	7500	7500	7500	10500	10500	10500	
Number of lanes	13	2	2	2	3	3	2	
Direction of road traffic	14	One way	One way	One way	One way	One way	Two way	
Deck Width (mm)	15	9900	10100	11800	12900	13400	14800	
Deck Configuration	As per which IRC Special Publication No. & Year	16	Nil	Nil	Nil	Nil	Nil	Nil
	Footpath (Nil/One-side/Two-side)	17	Nil	One side	Both side	Nil	One side	Both side
	Kerb (Nil/One-side/Two-side)	18	Both side	Nil	Nil	Both side	Nil	Nil
	Crash Barrier {Number-Type (RCC/W-Beam /Others)}	19	Both side RCC	Both side RCC	Both side RCC	Both side RCC	Both side RCC	Both side RCC
	Railing (RCC/Steel/ Others)	20	Nil	One side Steel	Both side Steel	Nil	One side Steel	Both side Steel

### List of RDSO Standard Drawings of Composite Plate Girders

Sl. No.		3						
Sub Sl. No.		3						
Drawing Identification No.	1	RDSO/B-11755						
Whether Fit for SV Loading	2	No						
Designed with Congestion Factor	3	No						
Month/ Year of Design	4	04/2013						
Month/ Year of Approval	5	04/2013						
Span (m)	6	30						
Depth of Girder (mm)	7	1705						
Seismic Zone designed for	8	V						
Angle of Skew designed for	9	Upto 20						
Degree of curvature designed for	10	Upto 10						
Number of Girders in one span	11	4	4	5	5	6	6	
Carriageway Width (mm)	12	7500	7500	7500	10500	10500	10500	
Number of lanes	13	2	2	2	3	3	2	
Direction of road traffic	14	One way	One way	One way	One way	One way	Two way	
Deck Width (mm)	15	9900	10100	11800	12900	13400	14800	
Deck Configuration	As per which IRC Special Publication No. & Year	16	Nil	Nil	Nil	Nil	Nil	Nil
	Footpath (Nil/One-side/Two-side)	17	Nil	One side	Both side	Nil	One side	Both side
	Kerb (Nil/One-side/Two-side)	18	Both side	Nil	Nil	Both side	Nil	Nil
	Crash Barrier {Number-Type (RCC/W-Beam /Others)}	19	Both side RCC	Both side RCC	Both side RCC	Both side RCC	Both side RCC	Both side RCC
	Railing (RCC/Steel/ Others)	20	Nil	One side Steel	Both side Steel	Nil	One side Steel	Both side Steel

### List of RDSO Standard Drawings of Composite Plate Girders

Sl. No.		4						
Sub Sl. No.		4						
Drawing Identification No.	1	RDSO/B-11758						
Whether Fit for SV Loading	2	No						
Designed with Congestion Factor	3	No						
Month/ Year of Design	4	04/2013						
Month/ Year of Approval	5	04/2013						
Span (m)	6	36						
Depth of Girder (mm)	7	2095						
Seismic Zone designed for	8	V						
Angle of Skew designed for	9	Upto 20						
Degree of curvature designed for	10	Upto 10						
Number of Girders in one span	11	4	4	5	5	6	6	
Carriageway Width (mm)	12	7500	7500	7500	10500	10500	10500	
Number of lanes	13	2	2	2	3	3	2	
Direction of road traffic	14	One way	One way	One way	One way	One way	Two way	
Deck Width (mm)	15	9900	10100	11800	12900	13400	14800	
Deck Configuration	As per which IRC Special Publication No. & Year	16	Nil	Nil	Nil	Nil	Nil	Nil
	Footpath (Nil/One-side/Two-side)	17	Nil	One side	Both side	Nil	One side	Both side
	Kerb (Nil/One-side/Two-side)	18	Both side	Nil	Nil	Both side	Nil	Nil
	Crash Barrier {Number-Type (RCC/W-Beam /Others)}	19	Both side RCC	Both side RCC	Both side RCC	Both side RCC	Both side RCC	Both side RCC
	Railing (RCC/Steel/ Others)	20	Nil	One side Steel	Both side Steel	Nil	One side Steel	Both side Steel

**List of RDSO Standard Drawings of Bow String Arch Girders**

Sl. No.		5	6	
Sub Sl. No.		1	2	
Drawing Identification Number	1	RDSO/B-10409/R1	RDSO/B-10407/R1	
Whether Fit for Special Vehicle Loading of IRC-6:2017	2	No	No	
Whether Designed with Congestion Factor	3	No	No	
Month/Year of Design	4	Oct-19	Nov-19	
Month Year of Approval of Design	5	-	-	
Span (m)	6	30.0	36.0	
Depth of Girder from bottom of girder to top of deck slab (mm)	7	1210	1210	
Number of Girders in one span	8	1	1	
Seismic Zone designed for	9	V	V	
Angle of Skew designed for	10	0	0	
Degree of curvature designed for	11	0	0	
Carriageway Width (mm)	12	7500	7500	
Number of lanes	13	2	2	
Direction of road traffic	14	Two way	Two way	
Deck Width (mm)	15	11700	11700	
Deck Configuration	As per which IRC Special Publication No. & Year	16	-	-
	Footpath (Nil/One-side/Two-side)	17	Both side	Both side
	Kerb (Nil/One-side/Two-side)	18	Nil	Nil
	Crash Barrier {Numbers-Type (RCC/W-Beam/Others)}	19	RCC	RCC
	Railing (RCC/Steel/Others)	20	Steel	Steel

<b>List of RDSO Standard Drawings of Bow String Arch Girders</b>				
	7	8	9	10
	3	4	5	6
1	RDSO/B-10408/R1	RDSO/B-10406/R	RDSO/B-10419/R	RDSO/B-10410/R1
2	No	No	No	No
3	No	No	No	No
4	Nov-19	May-15	Sep-20	Nov-20
5	-	-	-	-
6	42.0	48.0	48.0	54.0
7	1210	1210	1210	1210
8	1	1	1	1
9	V	IV	V	IV
10	0	0	0	0
11	0	0	0	0
12	7500	7500	7500	7500
13	2	2	2	2
14	Two way	Two way	Two way	Two way
15	11700	11700	11700	11700
16	-	-	-	-
17	Both side	Both side	Both side	Both side
18	Nil	Nil	Nil	Nil
19	RCC	RCC	RCC	RCC
20	Steel	Steel	Steel	Steel

<b>List of RDSO Standard Drawings of Bow String Arch Girders</b>				
Sl. No.			11	12
Sub Sl. No.			7	8
Drawing Identification Number		1	RDSO/B-10422/R	RDSO/B-10411/R1
Whether Fit for Special Vehicle Loading of IRC-6:2017		2	No	No
Whether Designed with Congestion Factor		3	No	No
Month/Year of Design		4	Jun-20	Dec-19
Month Year of Approval of Design		5	-	-
Span (m)		6	54	60
Depth of Girder from bottom of girder to top of deck slab (mm)		7	1210	1210
Number of Girders in one span		8	1	1
Seismic Zone designed for		9	V	IV
Angle of Skew designed for		10	0	0
Degree of curvature designed for		11	0	0
Carriageway Width (mm)		12	7500	7500
Number of lanes		13	2	2
Direction of road traffic		14	Two way	Two way
Deck Width (mm)		15	11700	11700
Deck Configuration	As per which IRC Special Publication No. & Year	16	-	-
	Footpath (Nil/One-side/Two-side)	17	Both side	Both side
	Kerb (Nil/One-side/Two-side)	18	Nil	Nil
	Crash Barrier {Numbers-Type (RCC/W-Beam/Others)}	19	RCC	RCC
	Railing (RCC/Steel/Others)	20	Steel	Steel



<b>List of RDSO Standard Drawings of Bow String Arch Girders</b>			
	13	14	15
	9	10	11
1	RDSO/B-10420/R	RDSO/B-10412/R	RDSO/B-10421/R
2	No	No	No
3	No	No	No
4	Jul-20	Jul-20	Aug-20
5	-		
6	60.0	72.0	72.0
7	1210	1210	1210
8	1	1	1
9	V	IV	V
10	0	0	0
11	0	0	0
12	7500	7500	7500
13	2	2	2
14	Two way	Two way	Two way
15	11700	11700	11700
16	-	-	-
17	Both side	Both side	Both side
18	Nil	Nil	Nil
19	RCC	RCC	RCC
20	Steel	Steel	Steel

This page is left blank intentionally.

**List of Non-RDSO drawings for other than Special  
Vehicle Loading**

CENTRAL RAILWAY				
Sl. No.			16	17
Sub Sl. No.			1	2
Drawing Identification Code		1	NSV-CR-CG-01	NSV-CR-CG-02
Designed by whom	Railway (CBE/CAO)	2	DY. CE	CBE
	PSU	3	NHAI	NHAI
Name of Consultant, if any	Design Consultant	4	Druta Designs	GR Infra Projects Limited
	Proof Consultant	5	VNIT Nagpur	VJTI Mumbai
Drawing Number		6	RP-ACP1-DD-P040-ROB 206+483-105	GR/WA-MA/STR/ROB/294
Whether Fit for Special Vehicle Loading of IRC-6:2017		7	No	No
Whether Designed with Congestion Factor		8	No	No
Month/Year of Design		9	Aug-21	Dec-19
Month Year of Approval of Design		10	Nov-21	May-20
Stations/Locations where used		11	Amravati-Chikhli	Watambare-Mangalwedha
Type of Superstructure		12	Composite Steel Girder	Composite Steel Girder
Span (m)		13	25	37.2
Depth of Girder including deck slab (mm)		14	2226	1931
Number of Girders in one span		15	5	7
Seismic Zone designed for		16	II	II
Angle of Skew (Degrees)		17	9	7.2
Degree of curvature designed for		18	0	0
Carriageway Width (mm)		19	9000	13000
Number of lanes		20	2	3
Direction of road traffic		21	One way	One way
Deck Width (mm)		22	12000	16000
Deck Configuration	As per which IRC Special Publication No. & Year	23	-	-
	Footpath (Nil/One-side/Two-side)	24	One side	One side
	Kerb (Nil/One-side/Two-side)	25	Nil	Nil
	Crash Barrier {Number- Type (RCC/ W-Beam /Others)}	26	Both side / RCC	Both side / RCC
	Railing (RCC/Steel/Others)	27	RCC	RCC

<b>EASTERN RAILWAY</b>				
Sl. No.		18	19	
Sub Sl. No.		1	2	
Drawing Identification Code		1 NSV-ER-BSG-01	NSV-ER-BSG-02	
Designed by whom	Railway (CBE/CAO)	2 CBE	CBE	
	PSU	3 -	-	
Name of Consultant, if any	Design Consultant	4 RITES (through L & T Ramboll)	RITES	
	Proof Consultant	5 IIT Guwahati	IIT Guwahati	
Drawing Number	6	CE's drg nos.B-399-2014 to B-444-2014.	GAD No.B-31-2014, Detailed Drawing nos B-332-2015 (SH-1 to 30)	
Whether Fit for Special Vehicle Loading of IRC-6:2017	7	No	No	
Whether Designed with Congestion Factor	8	No	No	
Month/Year of Design	9	Jun-14	Feb-15	
Month Year of Approval of Design	10	2014	Aug-15	
Stations/Locations where used	11	Park Circus	Mogra	
Type of Superstructure	12	Bowstring	Bowstring girder	
Span (m)	13	68.5	75	
Depth of Girder including deck slab (mm)	14	-	1719	
Number of Girders in one span	15	1	1	
Seismic Zone designed for	16	III	III	
Angle of Skew (Degrees)	17	0	0	
Degree of curvature designed for	18	0	0	
Carriageway Width (mm)	19	7500	11000	
Number of lanes	20	2	3	
Direction of road traffic	21	One way	One way	
Deck Width (mm)	22	8400	12000	
Deck Configuration	As per which IRC Special Publication No. & Year	23	-	-
	Footpath (Nil/One-side/Two-side)	24	Nil	Nil
	Kerb (Nil/One-side/Two-side)	25	Nil	Nil
	Crash Barrier {Number- Type (RCC/ W-Beam /Others)}	26	Both side RCC	Both side RCC
	Railing (RCC/Steel/Others)	27	Nil	Nil

<b>EAST CENTRAL RAILWAY</b>				
Sl. No.			20	21
Sub Sl. No.			1	2
Drawing Identification Code		1	NSV-ECR-BSG-01	NSV-ECR-OWG-01
Designed by whom	Railway (CBE/CAO)	2	Dy.CE/BR/D/ECR	DY. CE/BR/D/ECR
	PSU	3	-	-
Name of Consultant, if any	Design Consultant	4	IRCON International Limited	Aecom Asia Company Ltd.
	Proof Consultant	5	IIT Madras	IIT BOMBAY
Drawing Number		6	CE Drg No. ECR/MGS/2016-17/ROB/180	CE'S DRG. NO.- ECR/DNR/2018-19/ROB/237
Whether Fit for Special Vehicle Loading of IRC-6:2017		7	No	No
Whether Designed with Congestion Factor		8	No	No
Month/Year of Design		9	Dec-16	Aug-18
Month Year of Approval of Design		10	Mar-17	Jul-17
Stations/Locations where used		11	Manpur Bypass	DNR - Phulwari Sarif.
Type of Superstructure		12	Bowstring Girder	Truss Girder
Span (m)		13	58	104.3
Depth of Girder including deck slab (mm)		14	1380	1150
Number of Girders in one span		15	1	1
Seismic Zone designed for		16	III	IV
Angle of Skew (Degrees)		17	0	0
Degree of curvature designed for		18	0	0
Carriageway Width (mm)		19	10600	9100
Number of lanes		20	2	2
Direction of road traffic		21	Two way	One way
Deck Width (mm)		22	15200	12000
Deck Configuration	As per which IRC Special Publication No. & Year	23	-	-
	Footpath (Nil/One-side/Two-side)	24	Both sides	One Side
	Kerb (Nil/One-side/Two-side)	25	Nil	Nil
	Crash Barrier {Number- Type (RCC/ W-Beam /Others)}	26	Both side RCC	Both side RCC
	Railing (RCC/Steel/Others)	27	Steel	RCC

NORTHERN RAILWAY				
Sl. No.			22	23
Sub Sl. No.			1	2
Drawing Identification Code		1	NSV-NR-CG-01	NSV-NR-CG-02
Designed by whom	Railway (CBE/CAO)	2	CAO	CAO
	PSU	3	-	-
Name of Consultant, if any	Design Consultant	4	B&S Engineering Consultant Pvt Ltd	Structure Consultants Pvt Ltd
	Proof Consultant	5	IIT Roorkee	-
Drawing Number		6	P-1723-RB/2019	P-1395-RB/2017
Whether Fit for Special Vehicle Loading of IRC-6:2017		7	No	No
Whether Designed with Congestion Factor		8	Yes	Yes
Month/Year of Design		9	Dec-20	May-20
Month Year of Approval of Design		10	Dec-20	May-20
Stations/Locations where used		11	Delhi-Amritsar section near Bhandari	On MTC-KRJ Section
Type of Superstructure		12	Composite Steel Girder	Composite Steel Girder
Span (m)		13	20.8	27.716
Depth of Girder including deck slab (mm)		14	1514	2000
Number of Girders in one span		15	5	5
Seismic Zone designed for		16	IV	IV
Angle of Skew (Degrees)		17	0	40.571°
Degree of curvature designed for		18	0	14.5°
Carriageway Width (mm)		19	9500	7500
Number of lanes		20	2	2
Direction of road traffic		21	One way	Two way
Deck Width (mm)		22	12200	12200
Deck Configuration	As per which IRC Special Publication No. & Year	23	-	-
	Footpath (Nil/One-side/Two-side)	24	One side	Both Side
	Kerb (Nil/One-side/Two-side)	25	Nil	Nil
	Crash Barrier {Number- Type (RCC/ W-Beam /Others)}	26	2 Nos RCC	2 Nos RCC
	Railing (RCC/ Steel/Others)	27	Steel	RCC

<b>NORTHERN RAILWAY</b>				
Sl. No.			24	25
Sub Sl. No.			3	4
Drawing Identification Code		1	NSV-NR-CG-03	NSV-NR-CG-04
Designed by whom	Railway (CBE/CAO)	2	-	CAO
	PSU	3	-	-
Name of Consultant, if any	Design Consultant	4	CS Engineers and Consultant	Structure Consultants Pvt Ltd
	Proof Consultant	5	IIT BHU	-
Drawing Number		6	CSE&C/NR/LKO-UTR.SUP/01	P-1395-RB/2017
Whether Fit for Special Vehicle Loading of IRC-6:2017		7	No	No
Whether Designed with Congestion Factor		8	No	Yes
Month/Year of Design		9	Feb-21	May-19
Month Year of Approval of Design		10	Feb-21	May-19
Stations/Locations where used		11	UTR-SLN Section UP	On MTC-KRJ Section
Type of Superstructure		12	Composite Steel Girder	Composite Steel Girder
Span (m)		13	25.24	28.277
Depth of Girder including deck slab (mm)		14	1570	2000
Number of Girders in one span		15	8	5
Seismic Zone designed for		16	III	IV
Angle of Skew (Degrees)		17	8	7.88°
Degree of curvature designed for		18	0	14.5°
Carriageway Width (mm)		19	7500	7500
Number of lanes		20	2	2
Direction of road traffic		21	One way	Two Way
Deck Width (mm)		22	8500	12600
Deck Configuration	As per which IRC Special Publication No. & Year	23	-	-
	Footpath (Nil/One-side/Two-side)	24	Nil	Both Side
	Kerb (Nil/One-side/Two-side)	25	Nil	Nil
	Crash Barrier {Number- Type (RCC/ W-Beam /Others)}	26	Both side RCC	Both side RCC
	Railing (RCC/ Steel/Others)	27	Nil	RCC



<b>NORTHERN RAILWAY</b>				
	26	27	28	29
	5	6	7	8
1	NSV-NR-CG-05	NSV-NR-CG-06	NSV-NR-CG-07	NSV-NR-CG-08
2	CAO	CAO	-	CAO
3	-	-	-	-
4	Via Pontium Engineering Services	B&S Engineering Consultants Pvt Ltd	Stru tech Consultant Service Pvt Ltd	RICE Pvt Ltd
5	IIT BHU	M.A.N.I.T. Bhopal	Jamia Millia Islamia Delhi	IIT,BHU Varanasi
6	P-1960-RB/2020	P-1492-RB/2018	2019/NR/ROB-B359A/201	P-1638-RB/2019
7	No	No	No	No
8	No	No	Yes	Yes
9	Oct-21	Mar-19	Nov-19	Sep-21
10	Oct-21	Mar-19	Nov-19	Sep-21
11	Prayagraj Section near rly stn Prayag	Between Bhagtawala & Sangrana Rly Stn	MB-LKO Section	Between Rly Stn Ghaggar and Chandigarh
12	Composite Steel Girder	Composite Steel Girder	Composite Steel Girder	Composite Steel Girder
13	30	33.48	35.163	Varying from 35.382 to 38.085
14	2055	1831	2200	2097
15	5	7	4	6
16	III	IV	III	IV
17	0	37.02°	36	65°
18	0	0	0	53.62°
19	7500	7500 x 2	7500	8500
20	2	2	2	2
21	Two way	Two Way	Two way	One way
22	12000	17200	10100	13350
23	-	-	-	-
24	Both side	Nil	Nil	One side
25	Nil	Nil	Both side	Nil
26	2 Nos RCC	3 Nos RCC	2 Nos RCC	2 Nos RCC
27	Steel	Nil	Nil	Steel

<b>NORTHERN RAILWAY</b>				
Sl. No.			30	31
Sub Sl. No.			9	10
Drawing Identification Code		1	NSV-NR-CG-09	NSV-NR-CG-10
Designed by whom	Railway (CBE/CAO)	2	CAO	-
	PSU	3	-	-
Name of Consultant, if any	Design Consultant	4	Structure Consultants Pvt Ltd	Setu Consulting Engineers Faridabad
	Proof Consultant	5	-	IIT BHU
Drawing Number		6	P-1395-RB/2017	SCE/2015001/ROB/S UP/005
Whether Fit for Special Vehicle Loading of IRC-6:2017		7	No	No
Whether Designed with Congestion Factor		8	Yes	No
Month/Year of Design		9	Jul-19	May-15
Month Year of Approval of Design		10	Jul-19	May-15
Stations/Locations where used		11	On MTC-KRJ Section	Near Noli Railway Station
Type of Superstructure		12	Composite Steel Girder	Composite Steel Girder
Span (m)		13	38.3	43.75
Depth of Girder including deck slab (mm)		14	2400	2675
Number of Girders in one span		15	5	4
Seismic Zone designed for		16	IV	IV
Angle of Skew (Degrees)		17	49.440°	23
Degree of curvature designed for		18	0	Straight
Carriageway Width (mm)		19	7500	7500
Number of lanes		20	2	2
Direction of road traffic		21	Two Way	One way
Deck Width (mm)		22	12000	10350
Deck Configuration	As per which IRC Special Publication No. & Year	23	-	-
	Footpath (Nil/One-side/Two-side)	24	Both Side	One side
	Kerb (Nil/One-side/Two-side)	25	Nil	One side
	Crash Barrier {Number- Type (RCC/ W-Beam /Others)}	26	2 Nos RCC	2 Nos RCC
	Railing (RCC/ Steel/Others)	27	RCC	One side

<b>NORTHERN RAILWAY</b>				
	32	33	34	35
	11	12	13	14
1	NSV-NR-CG-11	NSV-NR-CG-12	NSV-NR-CG-13	NSV-NR-CG-14
2	CAO	CAO	-	CAO
3	-	-	-	-
4	Structure Consultants Pvt Ltd	Via Pontium Engineering Services	Rockwin India Consulting Engineers Pvt Ltd	RICE Pvt. Ltd.
5	-	IIT BHU	IIT BHU	IIT, BHU
6	P-1395-RB/2017	P-1960-RB/2020	ROB-119/DL1	P-1743-RB/2019
7	No	No	No	No
8	Yes	No	No	Yes
9	Jul-19	Sep-21	Aug-21	Mar-21
10	Jul-19	Sep-21	Aug-21	Mar-21
11	On MTC-KRJ Section	Allahabad-Prayagraj Section	Merut City Saharanpur	Rohtak-Meham Line
12	Composite Steel Girder	Composite Steel Girder	Composite Steel Girder	Composite Steel Girder
13	48.3	48.8	51.51	52.194
14	2850	2690	3150	3155
15	5	5	6	6
16	IV	III	III	IV
17	49.440°	0	0	65.20°
18	0	0	0	0
19	7500	7500	7500	10000
20	2	2	2	2
21	Two way	Two way	Two way	Two way
22	12000	12000	14500	14500
23	-	-	-	-
24	Both Side	Both side	Both side	Both Side
25	Nil	Nil	Both side	Nil
26	2 Nos RCC	2 Nos RCC	2 Nos RCC	2 Nos RCC
27	RCC	RCC	-	Steel

<b>NORTHERN RAILWAY</b>				
Sl. No.			36	37
Sub Sl. No.			15	16
Drawing Identification Code		1	NSV-NR-BSG-01	NSV-NR-BSG-02
Designed by whom	Railway (CBE/CAO)	2	CAO	CAO
	PSU	3	-	-
Name of Consultant, if any	Design Consultant	4	Structure Consultants Pvt. Ltd.	Structure Consultants Pvt. Ltd.
	Proof Consultant	5	Jamia Millia Islamia	NIT Kurukshetra
Drawing Number		6	P-1609-RB/2018	P-1722-RB/2019
Whether Fit for Special Vehicle Loading of IRC-6:2017		7	No	No
Whether Designed with Congestion Factor		8	No	No
Month/Year of Design		9	Feb-19	Feb-19
Month Year of Approval of Design		10	Feb-19	Feb-19
Stations/Locations where used		11	Jagraon Pul at Ludhiana on SNL-ASR SEC	Jind-Panipat Section at Jind City Stn
Type of Superstructure		12	Bowstring Girder	Bowstring Girder
Span (m)		13	62	74
Depth of Girder including deck slab (mm)		14	1401	1401
Number of Girders in one span		15	1	1
Seismic Zone designed for		16	IV	III
Angle of Skew (Degrees)		17	0	0
Degree of curvature designed for		18	0	0
Carriageway Width (mm)		19	10500	11000
Number of lanes		20	3	2
Direction of road traffic		21	One way	Two way
Deck Width (mm)		22	13500	16000
Deck Configuration	As per which IRC Special Publication No. & Year	23	-	-
	Footpath (Nil/One-side/Two-side)	24	One side	Two side
	Kerb (Nil/One-side/Two-side)	25	Nil	Nil
	Crash Barrier {Number- Type (RCC/ W-Beam /Others)}	26	2 Nos Type- RCC	2 Nos Type- RCC
	Railing (RCC/ Steel/Others)	27	Steel	Steel

NORTHERN RAILWAY		
	38	39
	17	18
1	NSV-NR-BSG-03	NSV-NR-OWG-01
2	CAO	CAO
3	-	-
4	Structure Consultants Pvt. Ltd.	B&S Engineering Consultants Pvt. Ltd.
5	Prof. Alok Goyal, IIT Bombay	Dr. Dipti Ranjan Sahoo, IIT Delhi
6	P-1125-RB/2016	P-1540-RB/2018
7	No	No
8	No	No
9	Jun-18	Jun-20
10	Jun-18	Jun-20
11	GZB-SRE section near GZB Rly station	Between Rly Stn Ghaziabad and Maripat
12	Bowstring Girder	Truss Girder
13	74.76	113
14	1371	2218 (Approved by RDSO)
15	1	1
16	IV	IV
17	0	0
18	0	0
19	9500	15000
20	2	4
21	Two way	One way
22	12000	16000
23	-	-
24	Nil	One Side
25	Both side	Nil
26	2 Nos. RCC	2 Nos. RCC
27	Others	Steel

NORTH EASTERN RAILWAY				
Sl. No.			40	41
Sub Sl. No.			1	2
Drawing Identification Code		1	NSV-NER-CG-01	NSV-NER-CG-02
Designed by whom	Railway (CBE/CAO)	2	-	-
	PSU	3	UPEIDA	NHAI
Name of Consultant, if any	Design Consultant	4	Lea Associate South Asia Pvt. Ltd	Monte Carlo Ltd
	Proof Consultant	5	IIT BHU	Civil Baba Infra Consultant Pvt Ltd
Drawing Number		6	7635G/LASA/STR /ROB-01/GA-01	CICPL/ D1008/ HW/DEG/ROB/02
Whether Fit for Special Vehicle Loading of IRC-6:2017		7	No	No
Whether Designed with Congestion Factor		8	No	No
Month/Year of Design		9	Feb-19	Mar-17
Month Year of Approval of Design		10	Feb-19	Mar-17
Stations/Locations where used		11	Karimuddinpur-Dhunadih	Domingarh to Jagatbela Gorakhpur
Type of Superstructure		12	Composite steel girder	Composite steel girder
Span (m)		13	36	42
Depth of Girder including deck slab (mm)		14	1631	2857
Number of Girders in one span		15	9	5
Seismic Zone designed for		16	IV	IV
Angle of Skew (Degrees)		17	0	36
Degree of curvature designed for		18	0	0
Carriageway Width (mm)		19	20250	9500
Number of lanes		20	5	2
Direction of road traffic		21	One way	One way
Deck Width (mm)		22	21250	12500
Deck Configuration	As per which IRC Special Publication No. & Year	23	-	-
	Footpath (Nil/One-side/Two-side)	24	Nil	One Side
	Kerb (Nil/One-side/Two-side)	25	Nil	Nil
	Crash Barrier {Number- Type (RCC/ W-Beam /Others)}	26	Both side RCC	Both side RCC
	Railing (RCC/ Steel/Others)	27	Nil	One Side

<b>NORTH EASTERN RAILWAY</b>	
	42
	3
1	NSV-NER-CG-03
2	-
3	NHAI
4	Civil Baba Infra Consultant Pvt Ltd
5	NIT Krukshetra
6	CICPL/D1008/HB/002
7	No
8	No
9	Apr. 2017
10	Apr. 2017
11	Gorakhpur Bypas Uttar Pradesh
12	Composite steel girder
13	42
14	2287
15	5
16	IV
17	60
18	0
19	9500
20	2
21	One way
22	12500
23	-
24	One side
25	One side
26	Both side RCC
27	One side

This page is left blank intentionally.



<b>NORTHEAST FRONTIER RAILWAY</b>				
Sl. No.			43	44
Sub Sl. No.			1	2
Drawing Identification Code		1	NSV-NFR-OWG-01	NSV-NFR-BSG-01
Designed by whom	Railway (CBE/CAO)	2	-	Dy. CE
	PSU	3	NHIDCL	PWD.WB.
Name of Consultant, if any	Design Consultant	4	PNG Planning & Structural Consultants	STUP Consultant Pvt. Ltd.
	Proof Consultant	5	IIT Guwahati	IIT Guwahati
Drawing Number		6	SRIKONA/ROB/N HIDCL/SIL/GAD	ROB/B/21/2018 series
Whether Fit for Special Vehicle Loading of IRC-6:2017		7	No	No
Whether Designed with Congestion Factor		8	No	Yes
Month/Year of Design		9	Nov-19	Sep-12
Month Year of Approval of Design		10	May-20	Jan-18
Stations/Locations where used		11	Srikona (Silchar)	Harishchandrapur
Type of Superstructure		12	Truss girder	Bow string girder
Span (m)		13	60	66
Depth of Girder including deck slab (mm)		14	956	1160
Number of Girders in one span		15	1	1
Seismic Zone designed for		16	V	V
Angle of Skew (Degrees)		17	0	0
Degree of curvature designed for		18	0	0
Carriageway Width (mm)		19	7500	11000
Number of lanes		20	2	2
Direction of road traffic		21	Two way	Two way
Deck Width (mm)		22	8500	16000
Deck Configuration	As per which IRC Special Publication No. & Year	23	IRC:SP 73- 2018	-
	Footpath (Nil/One-side/Two-side)	24	Both Side (Cantilever)	Both side
	Kerb (Nil/One-side/Two-side)	25	Nil	Nil
	Crash Barrier {Number- Type (RCC/ W-Beam /Others)}	26	Both side RCC	Both side RCC
	Railing (RCC/ Steel/Others)	27	Steel	Steel

NORTH WESTERN RAILWAY				
Sl. No.			45	46
Sub Sl. No.			1	2
Drawing Identification Code		1	NSV-NWR-CG-01	NSV-NWR-BSG-01
Designed by whom	Railway (CBE/CAO)	2	CBE	CAO
	PSU	3	NHAI	-
Name of Consultant, if any	Design Consultant	4	Strength Engg Service Pvt Ltd.	Spacechem Enterprises
	Proof Consultant	5	-	IIT Krurukshetra
Drawing Number		6	SSE/DFCIL/JP/ROB/ALIGNMENT/LC-85/GAD/01	CAO/C/JP/6142 TO 6154/D-JP ROB/RING ROAD
Whether Fit for Special Vehicle Loading of IRC-6:2017		7	No	No
Whether Designed with Congestion Factor		8	No	No
Month/Year of Design		9	Jun-14	Jun-18
Month Year of Approval of Design		10	Jun-14	Jun-18
Stations/Locations where used		11	Bhagega-Kanwat	Shivdaspura-Sananer CH:104.226)
Type of Superstructure		12	Composite steel girder	Bow string girder
Span (m)		13	36	44
Depth of Girder including deck slab (mm)		14	2095	1265
Number of Girders in one span		15	4	1
Seismic Zone designed for		16	-	II
Angle of Skew (Degrees)		17	36	16.43
Degree of curvature designed for		18	0	0
Carriageway Width (mm)		19	7500	12500
Number of lanes		20	2	3
Direction of road traffic		21	One way	One way
Deck Width (mm)		22	8500	13400
Deck Configuration	As per which IRC Special Publication No. & Year	23	-	-
	Footpath (Nil/One-side/Two-side)	24	Nil	Nil
	Kerb (Nil/One-side/Two-side)	25	Nil	Nil
	Crash Barrier {Number- Type (RCC/ W-Beam /Others)}	26	Both side RCC	Both side RCC
	Railing (RCC/ Steel/Others)	27	Nil	Nil

NORTH WESTERN RAILWAY		
	47	48
	3	4
1	NSV-NWR-CG-02	NSV-NWR-BSG-02
2	CAO	CAO
3	-	-
4	C.V.Kand Consultant	Spacechem Enterprises
5	Manit Bhopl	IIT Krurukshetra
6	CAO/C/JP/7063 TO 7068 /D-ROB DKB	CAO/C/JP/6155 TO 6170/D- ROB/RING ROAD
7	No	No
8	No	No
9	Sep-19	Jun-18
10	Sep-19	Jun-18
11	Dahar Ka Balaji	Kanota (CH:220/8-221/0)
12	Composite girder	Bow string girder
13	47.78	100
14	2750	1765
15	5	2
16	II	II
17	42.3	56
18	0	0
19	10500	12500
20	3	3
21	One way	One way
22	11500	13400
23	-	-
24	Nil	Nil
25	Nil	Nil
26	Both side RCC	Both side RCC
27	Nil	Nil

<b>SOUTHERN RAILWAY</b>				
Sl. No.			49	50
Sub Sl. No.			1	2
Drawing Identification Code		1	NSV-SR-CG-01	NSV-SR-CG-02
Designed by whom	Railway (CBE/CAO)	2	CBE	CBE
	PSU	3	NHAI	NHAI
Name of Consultant, if any	Design Consultant	4	Ruki Projects Pvt Ltd	Force Structural Engineers
	Proof Consultant	5	IIT Madras	IIT Mumbai
Drawing Number		6	CBE/GU1/180/2015	CBE/GV2/142/2017 Sheet 8 to 13, 21
Whether Fit for Special Vehicle Loading of IRC-6:2017		7	No	No
Whether Designed with Congestion Factor		8	No	No
Month/Year of Design		9	Dec-15	Nov-17
Month Year of Approval of Design		10	Dec-15	May-18
Stations/Locations where used		11	Maha Madurai - Aruppukottai Station	Nagercoil-Tovalai
Type of Superstructure		12	Composite Steel Girder	Composite Steel Girder
Span (m)		13	15	16.72
Depth of Girder including deck slab (mm)		14	1504	1504
Number of Girders in one span		15	5	5
Seismic Zone designed for		16	II	II
Angle of Skew (Degrees)		17	0	28
Degree of curvature designed for		18	0	0
Carriageway Width (mm)		19	9250	11000
Number of lanes		20	2	3
Direction of road traffic		21	One way	One way
Deck Width (mm)		22	12000	13750
Deck Configuration	As per which IRC Special Publication No. & Year	23	-	-
	Footpath (Nil/One-side/Two-side)	24	One side	One side
	Kerb (Nil/One-side/Two-side)	25	Nil	Nil
	Crash Barrier {Number- Type (RCC/ W-Beam /Others)}	26	Both side / RCC	Both side / RCC
	Railing (RCC/ Steel/Others)	27	RCC	RCC

<b>SOUTHERN RAILWAY</b>				
	51	52	53	54
	3	4	5	6
1	NSV-SR-CG-03	NSV-SR-CG-04	NSV-SR-CG-05	NSV-SR-CG-06
2	CBE	CBE	CBE	CBE
3	NHAI	NHAI	NHAI	NHAI
4	Samarth Infra Engg	Rucky Projects Ltd	Ruki Projects Pvt Ltd	Ruki Projects Pvt Ltd
5	IIT Madras	IIT Chennai	IIT Madras	IIT Madras
6	CBE/GU1/142/2010	CBE/GU1/161/2012 Sheet 18 to 23,30,32	CBE/GU1/165/2012	CBE/GU1/162/2012
7	No	No	No	No
8	No	No	No	No
9	Jul-15	Mar-17	Feb-16	May-16
10	Aug-15	Sep-17	Mar-16	May-16
11	Pudukottai-Vellanur Station	Sudiyur-Paramakkudi	Sediyar - Paramakkudi	Parmakkudi-Sattrakkudi Station
12	Composite Steel Girder	Composite Steel Girder	Composite Steel Girder	Composite Steel Girder
13	17.453	18.66	19.566	20.056
14	1914	1680	1504	1680
15	5	5	5	5
16	II	II	II	II
17	24	45	18	41
18	0	0	0	0
19	8400	9000	9000	9000
20	2	2	2	2
21	One way	One way	One way	One way
22	12900	12000	12000	12000
23	-	-		-
24	Both side	One side	One side	One side
25	Nil	Nil	Nil	Nil
26	Both side / RCC	Both side / RCC	Both side / RCC	Both side / RCC
27	RCC	RCC	RCC	RCC

<b>SOUTHERN RAILWAY</b>				
Sl. No.			55	56
Sub Sl. No.			7	8
Drawing Identification Code		1	NSV-SR-CG-07	NSV-SR-CG-08
Designed by whom	Railway (CBE/CAO)	2	CBE	CBE
	PSU	3	NHAI	NHAI
Name of Consultant, if any	Design Consultant	4	Force Structural Engineers	Ruki Projects Pvt Ltd
	Proof Consultant	5	IIT Mumbai	IIT/Chennai
Drawing Number		6	CBE/GV2/142/2 017 Sheet 14 to 21	CBE/GU1/174/2014
Whether Fit for Special Vehicle Loading of IRC-6:2017		7	No	No
Whether Designed with Congestion Factor		8	No	No
Month/Year of Design		9	Nov-17	Sep-14
Month Year of Approval of Design		10	May-18	Sep-14
Stations/Locations where used		11	Nagercoil-Tovalai	Madurai-Silaiman Jn
Type of Superstructure		12	Composite Steel Girder	Composite Steel Girder
Span (m)		13	20.32	24.905
Depth of Girder including deck slab (mm)		14	1504	2039
Number of Girders in one span		15	5	5
Seismic Zone designed for		16	II	II
Angle of Skew (Degrees)		17	28	52° 58'
Degree of curvature designed for		18	0	0
Carriageway Width (mm)		19	11000	9000
Number of lanes		20	3	2
Direction of road traffic		21	One way	One way
Deck Width (mm)		22	13750	12000
Deck Configuration	As per which IRC Special Publication No. & Year	23	-	-
	Footpath (Nil/One-side/Two-side)	24	One side	One side
	Kerb (Nil/One-side/Two-side)	25	Nil	Nil
	Crash Barrier {Number- Type (RCC/ W-Beam /Others)}	26	Both side / RCC	Both side / RCC
	Railing (RCC/ Steel/Others)	27	RCC	RCC

<b>SOUTHERN RAILWAY</b>				
	57	58	59	60
	9	10	11	12
1	NSV-SR-CG-09	NSV-SR-CG-10	NSV-SR-CG-11	NSV-SR-CG-12
2	CBE	CBE	CBE	CBE
3	NHAI	NHAI	NHAI	NHAI
4	Rucky projects Ltd	Samarth Infra Engg	Ruki Projects Pvt Ltd	Ruki Projects Pvt Ltd
5	IIT/Chennai	IIT Madras	IIT Madras	IIT Chennai
6	CBE/GU1/164 /2012 Sheet 20 to 26, 34,36	CBE/GU1/142/2 010	CBE/GU1/162/20 12	CBE/GU1/175/20 14
7	No	No	No	No
8	No	No	No	No
9	Jan-17	Jul-15	May-16	Sep-14
10	May-17	Aug-15	May-16	Sep-14
11	Tirupachetti-Manamadurai	Pudukottai-Vellanur Station	Parmakkudi-Sattrakkudi Station	Silaiman - Tiruppuvanam Jn Station
12	Composite Steel Girder	Composite Steel Girder	Composite Steel Girder	Composite Steel Girder
13	25.17	26.7	26.74	27.826
14	2039	2276	2055	2039
15	5	5	5	5
16	II	II	II	II
17	42° 33'	24	41	44
18	-	0	0	0
19	9000	8400	9000	9000
20	2	2	2	2
21	One way	Two way	One way	One way
22	12000	12900	12000	12000
23		-	-	-
24	One side	Both side	One side	One side
25	Nil	Nil	Nil	Nil
26	Both side/ RCC	Both side / RCC	Both side / RCC	Both side / RCC
27	RCC	RCC	RCC	RCC

<b>SOUTHERN RAILWAY</b>				
Sl. No.			61	62
Sub Sl. No.			13	14
Drawing Identification Code		1	NSV-SR-CG-13	NSV-SR-CG-14
Designed by whom	Railway (CBE/CAO)	2	CBE	CBE
	PSU	3	NHAI	NHAI
Name of Consultant, if any	Design Consultant	4	Ruki Projects Pvt Ltd	Raj Infra Engineers
	Proof Consultant	5	IIT Madras	IIT Mumbai
Drawing Number		6	CBE/GU1/165/2012	CBE/GT3/183/2013 Sheet 7 to 17
Whether Fit for Special Vehicle Loading of IRC-6:2017		7	No	No
Whether Designed with Congestion Factor		8	No	No
Month/Year of Design		9	Feb-16	Dec-18
Month Year of Approval of Design		10	Mar-16	Feb-19
Stations/Locations where used		11	Sediyar - Paramakkudi	Kurunjipadi-Vadalur
Type of Superstructure		12	Composite Steel Girder	Composite Steel Girder
Span (m)		13	29.45	29.745
Depth of Girder including deck slab (mm)		14	2055	1575
Number of Girders in one span		15	5	5
Seismic Zone designed for		16	II	II
Angle of Skew (Degrees)		17	18	8
Degree of curvature designed for		18	0	-
Carriageway Width (mm)		19	9000	9000
Number of lanes		20	2	2
Direction of road traffic		21	One way	One way
Deck Width (mm)		22	12000	12000
Deck Configuration	As per which IRC Special Publication No. & Year	23	-	-
	Footpath (Nil/One-side/Two-side)	24	One side	One side
	Kerb (Nil/One-side/Two-side)	25	Nil	Nil
	Crash Barrier {Number- Type (RCC/ W-Beam /Others)}	26	Both side / RCC	Both side / RCC
	Railing (RCC/ Steel/Others)	27	RCC	RCC



<b>SOUTHERN RAILWAY</b>				
	63	64	65	66
	15	16	17	18
1	NSV-SR-CG-15	NSV-SR-CG-16	NSV-SR-CG-17	NSV-SR-CG-18
2	CBE	CBE	CBE	CBE
3	NHAI	NHAI	NHAI	NHAI
4	Rucky Projects Ltd	Ruki Projects Pvt Ltd	Rucky Projects Ltd	Rucky Projects Ltd
5	IIT Chennai	IIT Madras	IIT Chennai	IIT Chennai
6	CBE/GU1/159/2012 Sheet 62 to 68 & 93	CBE/GU1/180/2015	CBE/GU1/159/2012 Sheet 84 to 90, 96	CBE/GU1/164/2012 Sheet 27 to 33, 35
7	No	No	No	No
8	No	No	No	No
9	Jun-17	Dec-15	Jun-17	Jan-17
10	Feb-18	Dec-15	Feb-18	May-17
11	Silaiman-Tirupavanam	Maha Madurai - Aruppukottai Station	Silaiman-Tirupavanam	Tirupachetti-Manamadurai
12	Composite Steel Girder	Composite Steel Girder	Composite Steel Girder	Composite Steel Girder
13	31.12	32	33.1	34.2
14	2130	2055	2285	2340
15	5	5	5	5
16	II	II	II	II
17	54°15'	0	57	42° 33'
18	Radius of 400m	0	Radius of 400m	-
19	9000	9250	9000	9000
20	2	2	2	2
21	One way	One way	One way	One way
22	12000	12000	12000	12000
23	-	-	-	-
24	One side	One side	One side	One side
25	Nil	Nil	Nil	Nil
26	Both side / RCC	Both side / RCC	Both side / RCC	Both side / RCC
27	RCC	RCC	RCC	RCC

<b>SOUTHERN RAILWAY</b>				
Sl. No.			67	68
Sub Sl. No.			19	20
Drawing Identification Code		1	NSV-SR-CG-19	NSV-SR-CG-20
Designed by whom	Railway (CBE/CAO)	2	CBE	CBE
	PSU	3	NHAI	NHAI
Name of Consultant, if any	Design Consultant	4	Rucky Projects Ltd	Rucky Projects Ltd
	Proof Consultant	5	IIT Chennai	IIT Chennai
Drawing Number		6	CBE/GU1/159/2012	CBE/GU1/161/2012 Sheet 24 to 29,31
Whether Fit for Special Vehicle Loading of IRC-6:2017		7	No	No
Whether Designed with Congestion Factor		8	No	No
Month/Year of Design		9	Jun-17	Mar-17
Month Year of Approval of Design		10	Feb-18	Sep-17
Stations/Locations where used		11	Silaiman-Tirupavanam	Sudiyur-Paramakudi
Type of Superstructure		12	Composite Steel Girder	Composite Steel Girder
Span (m)		13	34.675	35.35
Depth of Girder including deck slab (mm)		14	2390	2445
Number of Girders in one span		15	5	5
Seismic Zone designed for		16	II	II
Angle of Skew (Degrees)		17	58° 43'	45°
Degree of curvature designed for		18	Radius of 400m	-
Carriageway Width (mm)		19	9000	9000
Number of lanes		20	2	2
Direction of road traffic		21	One way	One way
Deck Width (mm)		22	12000	12000
Deck Configuration	As per which IRC Special Publication No. & Year	23	-	-
	Footpath (Nil/One-side/Two-side)	24	One side	One side
	Kerb (Nil/One-side/Two-side)	25	Nil	Nil
	Crash Barrier {Number- Type (RCC/ W-Beam /Others)}	26	Both side / RCC	Both side / RCC
	Railing (RCC/ Steel/Others)	27	RCC	RCC

<b>SOUTHERN RAILWAY</b>				
	69	70	71	72
	21	22	23	24
1	NSV-SR-CG-21	NSV-SR-CG-22	NSV-SR-CG-23	NSV-SR-CG-24
2	CBE	CBE	CBE	CBE
3	NHAI	NHAI	NHAI	NHAI
4	Ruki Projects Pvt Ltd	Rucky projects Ltd	Ruki Projects Pvt Ltd	Ruki Projects Pvt Ltd
5	IIT Madras	IIT Chennai	IIT Madras	IIT Chennai
6	CBE/GU1/180/2015	CBE/GU1/159/2012 Sheet 77 to 83,95	CBE/GU1/160/2012	CBE/GU1/174/2014
7	No	No	No	No
8	No	No	No	No
9	Dec-15	Jun-17	Apr-16	Sep-14
10	Dec-15	Feb-18	Apr-16	Sep-14
11	Maha Madurai - Aruppukottai Station	Silaiman-Tirupavanam	Tiruppuvanam-Tiruppavhetti Jn Station	Madurai-Silaiman Jn
12	Composite Steel Girder	Composite Steel Girder	Composite Steel Girder	Composite Steel Girder
13	37	38.74	38.97	41.508
14	2445	2556	2550	2751
15	5	5	5	5
16	II	II	II	II
17	0	62°18'	62	52° 58'
18	0	Radius of 400m	0	0
19	9250	9000	9000	9000
20	2	2	2	2
21	One way	One way	One way	One way
22	12000	12000	12000	12000
23	-	-	-	-
24	One side	One side	One side	One side
25	Nil	Nil	Nil	Nil
26	Both side / RCC	Both side / RCC	Both side / RCC	Both side / RCC
27	RCC	RCC	RCC	RCC

<b>SOUTHERN RAILWAY</b>				
Sl. No.			73	74
Sub Sl. No.			25	26
Drawing Identification Code		1	NSV-SR-CG-25	NSV-SR-CG-26
Designed by whom	Railway (CBE/CAO)	2	CBE	CBE
	PSU	3	NHAI	NHAI
Name of Consultant, if any	Design Consultant	4	Ruki Projects Pvt Ltd	Rucky projects Ltd
	Proof Consultant	5	IIT Chennai	IIT Chennai
Drawing Number		6	CBE/GU1/175/2014	CBE/GU1/159/2012
Whether Fit for Special Vehicle Loading of IRC-6:2017		7	No	No
Whether Designed with Congestion Factor		8	No	No
Month/Year of Design		9	Sep-14	Jun-17
Month Year of Approval of Design		10	Sep-14	Feb-18
Stations/Locations where used		11	Silaiman - Tiruppuvanam Jn Station	Silaiman-Tirupavanam
Type of Superstructure		12	Composite Steel Girder	Composite Steel Girder
Span (m)		13	41.739	41.95m
Depth of Girder including deck slab (mm)		14	2740	2763
Number of Girders in one span		15	5	6
Seismic Zone designed for		16	II	II
Angle of Skew (Degrees)		17	44	64
Degree of curvature designed for		18	0	Radius of 400m
Carriageway Width (mm)		19	9000	9000
Number of lanes		20	2	2
Direction of road traffic		21	One way	One way
Deck Width (mm)		22	12000	12000
Deck Configuration	As per which IRC Special Publication No. & Year	23	-	-
	Footpath (Nil/One-side/Two-side)	24	One side	One side
	Kerb (Nil/One-side/Two-side)	25	Nil	Nil
	Crash Barrier {Number- Type (RCC/ W-Beam /Others)}	26	Both side / RCC	Both side / RCC
	Railing (RCC/ Steel/Others)	27	RCC	RCC

<b>SOUTHERN RAILWAY</b>				
	75	76	77	78
	27	28	29	30
1	NSV-SR-CG-27	NSV-SR-CG-28	NSV-SR-CG-29	NSV-SR-CG-30
2	CBE	CBE	CBE	CBE
3	NHAI	NHAI	NHAI	MORTH
4	Mukesh & Associates	Ruki Projects Pvt Ltd	Rucky Projects Ltd	Nagesh Consultancy
5	IIT Chennai	IIT Chennai	IIT Chennai	IIT Chennai
6	CBE/GU3/162/2018	CBE/GV1/296/2016	CBE/GU1/159/2012 Sheet 69 to 76, 94	CBE/GV2/142/2017
7	No	No	No	No
8	No	No	No	No
9	Aug-18	Dec-16	Jun-17	Sep-17
10	Aug-18	Nov-17	Feb-18	Sep-17
11	Dindigul-Pollachi Section	Kochuveli-Thiruvananthapuram	Silaiman-Tirupavanam	Alappuzha - Kayamkulam
12	Composite Steel Girder	Composite Steel Girder	Composite Steel Girder	Composite Steel Girder
13	42	45.5	49.67	53
14	2300	2850	3358	2890
15	6	5	5	5
16	II	III	II	III
17	30	32	68° 43'	0
18	0	0	Radius of 400m	0
19	11000	9500	9000	11000
20	3	2	2	2
21	One way	One way	One way	Two way
22	13800	12500	12000	12000
23	-	-		-
24	One side	One side	One side	Nil
25	Nil	One side	Nil	Nil
26	Both side / RCC	Both side / RCC	Both side / RCC	Both side / RCC
27	Steel	RCC	RCC	Nil

This page is left blank intentionally.

<b>SOUTHERN RAILWAY</b>			
Sl. No.			79
Sub Sl. No.			31
Drawing Identification Code		1	NSV-SR-BSG-01
Designed by whom	Railway (CBE/CAO)	2	CBE
	PSU	3	NHAI
Name of Consultant, if any	Design Consultant	4	RCC Infra Consultants
	Proof Consultant	5	-
Drawing Number		6	CBE/GJ3/128/2016 Sheet 10 to 36
Whether Fit for Special Vehicle Loading of IRC-6:2017		7	No
Whether Designed with Congestion Factor		8	No
Month/Year of Design		9	Jun-16
Month Year of Approval of Design		10	Jun-16
Stations/Locations where used		11	Pollachi-Kinathukadavau
Type of Superstructure		12	Bow string girder
Span (m)		13	62
Depth of Girder including deck slab (mm)		14	1360
Number of Girders in one span		15	1
Seismic Zone designed for		16	II
Angle of Skew (Degrees)		17	0
Degree of curvature designed for		18	0
Carriageway Width (mm)		19	8000
Number of lanes		20	2
Direction of road traffic		21	One way
Deck Width (mm)		22	11000
Deck Configuration	As per which IRC Special Publication No. & Year	23	-
	Footpath (Nil/One-side/Two-side)	24	One side
	Kerb (Nil/One-side/Two-side)	25	Nil
	Crash Barrier {Number- Type (RCC/W-Beam /Others)}	26	Both side / RCC
	Railing (RCC/Steel/Others)	27	RCC

<b>SOUTH EAST CENTRAL RAILWAY</b>				
Sl. No.			80	81
Sub Sl. No.			1	2
Drawing Identification Code		1	NSV-SECR-CG-01	NSV-SECR-CG-02
Designed by whom	Railway (CBE/CAO)	2	CBE	CBE
	PSU	3	-	-
Name of Consultant, if any	Design Consultant	4	DECON/Bhopal	L&T
	Proof Consultant	5	VNIT/NGP	IIT Madras
Drawing Number		6	AMANKA/ROB/M GBP/06	O15107-C-RP-RB-RC-0011
Whether Fit for Special Vehicle Loading of IRC-6:2017		7	No	No
Whether Designed with Congestion Factor		8	No	No
Month/Year of Design		9	Apr-17	Jul-16
Month Year of Approval of Design		10	Apr-17	Jul-16
Stations/Locations where used		11	SZB-URK 831/25-27	BTC-JBH-1195/5-6
Type of Superstructure		12	Composite steel girder	Composite steel girder
Span (m)		13	36	36
Depth of Girder including deck slab (mm)		14	2095	2057
Number of Girders in one span		15	6	6
Seismic Zone designed for		16	II	II
Angle of Skew (Degrees)		17	45	66
Degree of curvature designed for		18	0	0
Carriageway Width (mm)		19	10500	8500
Number of lanes		20	2	2
Direction of road traffic		21	Two way	One way
Deck Width (mm)		22	13400	12000
Deck Configuration	As per which IRC Special Publication No. & Year	23	-	-
	Footpath (Nil/One-side/Two-side)	24	Nil	One side
	Kerb (Nil/One-side/Two-side)	25	Nil	One side
	Crash Barrier {Number- Type (RCC/ W-Beam /Others)}	26	Both side RCC	Both side RCC
	Railing (RCC/Steel/Others)	27	One side RCC	One side RCC



SOUTH EAST CENTRAL RAILWAY		
	82	83
	3	4
1	NSV-SECR-CG-03	NSV-SECR-OWG-01
2	CBE	CBE
3	-	-
4	L &T	Unique Engineers
5	IIT Mumbai	NIT Kurukshetra
6	O14043-C-RP-RB-DD-0002	1279/26
7	No	No
8	No	No
9	Mar-16	Aug-18
10	Apr-16	Aug-18
11	BPH-BRJN 533/17-19	Bilaspur Katni Section
12	Composite steel girder	Truss girder
13	41.6	81
14	2295	-
15	6	1
16	II	II
17	0	0
18	0	0
19	10500	11000
20	2	2
21	Two way	Two Way
22	14800	12000
23	-	-
24	Both side	Nil
25	Nil	Nil
26	Both side RCC	Both side RCC
27	Both side	Nil

This page is left blank intentionally.

<b>SOUTH WESTERN RAILWAY</b>				
Sl. No.			84	85
Sub Sl. No.			1	2
Drawing Identification Code		1	NSV-SWR-CG-01	NSV-SWR-CG-02
Designed by whom	Railway (CBE/CAO)	2	CBE	CBE
	PSU	3	-	NHAI
Name of Consultant, if any	Design Consultant	4	Feedback Infra	Feedback Infra
	Proof Consultant	5	IIT Madras	IIT Madras
Drawing Number		6	ROB/320	SWR/2018/STR-10/ROB
Whether Fit for Special Vehicle Loading of IRC-6:2017		7	No	No
Whether Designed with Congestion Factor		8	No	No
Month/Year of Design		9	-	-
Month Year of Approval of Design		10	2018	Jul-18
Stations/Locations where used		11	CTA-BHAI	Chitradurga-Harihar Section
Type of Superstructure		12	Composite steel girder	Composite steel girder
Span (m)		13	36	36
Depth of Girder including deck slab (mm)		14	2095	2510
Number of Girders in one span		15	7	7
Seismic Zone designed for		16	II	II
Angle of Skew (Degrees)		17	5° 6'	50
Degree of curvature designed for		18	0	0
Carriageway Width (mm)		19	12000	12000
Number of lanes		20	3	3
Direction of road traffic		21	One way	One way
Deck Width (mm)		22	16000	16000
Deck Configuration	As per which IRC Special Publication No. & Year	23	-	-
	Footpath (Nil/One-side/Two-side)	24	One side	One side
	Kerb (Nil/One-side/Two-side)	25	Two side	Two side
	Crash Barrier {Number- Type (RCC/ W-Beam /Others)}	26	Two side RCC	Two side RCC
	Railing (RCC/Steel/Others)	27	RCC	RCC

<b>WESTERN RAILWAY</b>				
Sl. No.			86	87
Sub Sl. No.			1	2
Drawing Identification Code		1	NSV-WR-CG-01	NSV-WR-CG-02
Designed by whom	Railway (CBE/CAO)	2	CAO	CAO
	PSU	3	NHAI	NHAI
Name of Consultant, if any	Design Consultant	4	Manthan Setu Path Engineering and Consultant	Manthan Setu Path Engineering and Consultant
	Proof Consultant	5	-	-
Drawing Number		6	CAO (C ) CCG/2974B/D- WDHR-MALB	CAO (C ) CCG/29749/D-WDHR- MALB
Whether Fit for Special Vehicle Loading of IRC-6:2017		7	No	No
Whether Designed with Congestion Factor		8	No	No
Month/Year of Design		9	Oct-21	Nov-21
Month Year of Approval of Design		10	Nov-21	Nov-21
Stations/Locations where used		11	MALB-WDHR Ahmedabad	MALB-INDR Ahmedabad
Type of Superstructure		12	Composite steel girder	Composite steel girder
Span (m)		13	30	36
Depth of Girder including deck slab (mm)		14	1750	2000
Number of Girders in one span		15	7	7
Seismic Zone designed for		16	III	III
Angle of Skew (Degrees)		17	45.51	32.42
Degree of curvature designed for		18	0	0
Carriageway Width (mm)		19	14000	14000
Number of lanes		20	3	3
Direction of road traffic		21	One way	One way
Deck Width (mm)		22	17000	17000
Deck Configuration	As per which IRC Special Publication No. & Year	23	-	-
	Footpath (Nil/One-side/Two-side)	24	One side	One side
	Kerb (Nil/One-side/Two-side)	25	Nil	Nil
	Crash Barrier {Number- Type (RCC/ W-Beam /Others)}	26	Both side RCC	Both side RCC
	Railing (RCC/Steel/Others)	27	One side	One side

<b>WESTERN RAILWAY</b>				
	88	89	90	91
	3	4	5	6
1	NSV-WR-CG-03	NSV-WR-CG-04	NSV-WR-CG-05	NSV-WR-OWG-01
2	CBE	CAO	CBE	CBE
3	-	-	-	-
4	Casad Consultant Ahmedabad	Multimedia Consultant Pvt Ltd	Specialized Engineering Service Pvt Ltd	Multi Media Consultant, Ahmedabad.
5	SVNIT-Surat	SV NIT Surat	IIT BHU	IIT Mumbai
6	SMC/ROB- 445/SUP-40	CAO( C)/CCG/29820/ D- VG-G/M	SES/PIL/MUM BAI- VADODRA/BR/ 201	ROB/CIMS- HOSP/TRUSS_021
7	No	No	No	No
8	No	No	No	No
9	Jun-21	Mar-21	Jun-21	Jul-20
10	Jun-21	Mar-21	Jun-21	Jul-20
11	Surat-Udhana (Culvert 445) KM.265/9-13	Viramgam- Mandal-Dasada	Manubar to Sanpa Section Vadodara Mumbai Expressway	CIMS Hospital- Hebatpur Road ADI-VG Section KM.509/7-8
12	Composite steel girder	Composite steel girder	Composite steel girder	Truss girder
13	40	41	44	52.8
14	2400	2545	2556	1100
15	5	6	9	1
16	III	III	III	III
17	0	20	45	0
18	0	0	0	0
19	10350	11000	20250	7500
20	3	3	6	2
21	One way	One way	One way	One way
22	11250	13800	21250	10300
23	-	-	-	-
24	Nil	One side	Nil	One side
25	Nil	One	Nil	Nil
26	Both side RCC	Both side RCC	Both side RCC	Both side RCC
27	Nil	One side	Nil	One side

WESTERN RAILWAY				
Sl. No.			92	93
Sub Sl. No.			7	8
Drawing Identification Code		1	NSV-WR-OWG-02	NSV-WR-CG-06
Designed by whom	Railway (CBE/CAO)	2	CBE	CAO
	PSU	3		
Name of Consultant, if any	Design Consultant	4	Multi Media Consultant, Ahmedabad.	Multimedia Consultant Pvt Ltd
	Proof Consultant	5	IIT Mumbai	
Drawing Number		6	LC114_ROB_DHANDUKA_TRUSS_01a	ROB-SHILAJ-03
Whether Fit for Special Vehicle Loading of IRC-6:2017		7	No	No
Whether Designed with Congestion Factor		8	No	No
Month/Year of Design		9	Dec-20	Jan-16
Month Year of Approval of Design		10	Dec-20	Feb-16
Stations/Locations where used		11	Bagodara-Dhandhuka Road KM.126/7 & 126/8 IN Lieu OF L.C. NO. 114-B/2-T	Thaltej Shilaj Rancharda Road Ahmedabad
Type of Superstructure		12	Truss girder	Composite steel girder
Span (m)		13	52.8	64.8
Depth of Girder including deck slab (mm)		14	-	-
Number of Girders in one span		15	1	4
Seismic Zone designed for		16	III	III
Angle of Skew (Degrees)		17	0	0
Degree of curvature designed for		18	0	0
Carriageway Width (mm)		19	7500	7500
Number of lanes		20	2	2
Direction of road traffic		21	One way	One way
Deck Width (mm)		22	10300	10200
Deck Configuration	As per which IRC Special Publication No. & Year	23	-	-
	Footpath (Nil/One-side/Two-side)	24	One side	One side
	Kerb (Nil/One-side/Two-side)	25	Nil	Nil
	Crash Barrier {Number- Type (RCC/ W-Beam /Others)}	26	Both side RCC	Both side RCC
	Railing (RCC/Steel/Others)	27	One side	One side

<b>WESTERN RAILWAY</b>				
	94	95	96	97
	9	10	11	12
1	NSV-WR-OWG-03	NSV-WR-OWG-04	NSV-WR-OWG-05	NSV-WR-OWG-06
2	CBE	CBE	CBE	CAO
3	-	-	-	-
4	STUP Consultants Pvt Ltd Mumbai	Prof.D.D.Desai-Mumbai & Spectrum Techno Consultants - Mumbai	TPF Engineering Pvt Ltd	Casad Consultant Pvt Ltd
5	IIT Mumbai	IIT Roorkee	IIT Mumbai	IIT Mumbai
6	8040/E/DD-170	WDFC/CPM/BRC/LC_NO_150	PCE/27676/DRM-1-D	AMC/KROB/RW/S.S/GAD
7	No	No	No	No
8	Yes	No	Yes	No
9	Nov-20	Mar-21	Aug-19	Oct-20
10	Nov-20	Mar-21	Aug-19	Nov-20
11	Vasadva-Dhrangdra/KM.618-13-14 (LC-41 SPL)	Sayan-Gothangam at LC-150	Lower Parel Station (Delisle)	Mani Nagar - Ahmedabad
12	Truss girder	Truss girder	Truss girder	Truss girder
13	71.11	71.11	85.09	92
14	1140	1140	-	1000
15	1	1	1	1
16	IV	III	III	III
17	0	0	64.405	0
18	0	0	0	0
19	11000	7500	11000	7500
20	3	2	2	2
21	One way	Two way	Two way	One way
22	12900	8500	13000	10025
23	-	-	-	
24	One side	Both side	One side	One side
25	One	Nil	Two side	One
26	Both side RCC	Both side RCC	Both side RCC	Both side RCC
27	One side	Both side	One side	One side

This page is left blank intentionally.



**Chapter V**  
**Instructions regarding approval of non-RDSO**  
**Drawings**

This page is left blank intentionally.

The latest instructions issued by Railway Board regarding approval of drawings are being reproduced below for the ready reference:

**GOVERNMENT OF INDIA  
MINISTRY OF RAILWAYS  
(RAILWAY BOARD)**

No. 2016/54/CE-III/BR/RDSO/Misc.

New Delhi dt: 12.02.2021

**Principal Chief Engineer,  
All Zonal Railways.**

**Chief Administrative Officer (Con.)  
All Zonal Railways.**

**Sub:** Design of Non-Standard composite Girders for ROBs.

**Ref:** (i) Board's letter No. 2015/CE-IV/ROB/78 Pt. dt. 23.06.20.

(ii) Board's letter of even number dated 21.09.20.

**Time and again instructions have been issued to adopt standard design of steel girders issued by RDSO for ROBs from safety consideration as well as to expedite execution of work.** However, in unavoidable circumstances Non-standard span can be used due to site constraints.

Vide ref. (i) it was advised that CBE of Zonal Railways will approve design of Non-standard girders of ROBs on National Highways. Further, instructions were issued vide ref. (ii) for approval of design of Non-standard composite steel plate girders by Zonal Railways and approval of Non-Standard Bow String/Truss type girders after clearance of RDSO.

To expedite the construction of ROBs it has been decided that approval of design of Non-standard steel girders (Composite as well as Bow String) shall be done by CBE of Zonal Railways. However, in exceptional cases, they may seek guidance of RDSO for checking a particular component.

Above instructions are applicable for construction of ROBs in new line & gauge conversion works also. Further, in such cases, CE/Const. is authorized to approve the GAD & design in place of CBE and he will be responsible to ensure the compliance of above instructions.

Recently, RDSO has been advised to design one span of truss type of ROB girder for which work is in progress. However, if some Zonal Railway want to use truss type girder of ROB, in such cases, design and drawing has to be submitted to RDSO. Design of the same will be checked and issued by RDSO as standard drawing.

This supersedes all earlier instructions on this subject.

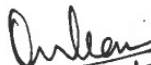
  
12/02/2021

**(O.N. Sharma)  
Dir. CE(B&S)**

**Copy:**

- (i) PED/Bridge, RDSO for information and necessary action.
- (ii) CPD/BWs and CBEs, All Zonal Railways for information and necessary action.

This page is left blank intentionally.

## **Chapter VI**

### **Summary of technical publications issued by RDSO for execution of ROBs**

This page is left blank intentionally.

## **6.1 Welded Bridge Code- Indian Railway Standard Code of Practices for Metal Arc Welding for Structural Steel Bridges carrying Rail Cum Road or Pedestrian Traffic (Adopted 1972 Revised 2001).**

This Code of Practice applies to the design, construction and inspection of welds made by Manual, Automatic or Semi-automatic metal arc process in new and existing structural steel bridges.

It broadly covers various types of welds, strengthening of existing bridges, approval and testing of welding procedures, approval and testing of welders, sequence of welding, inspection requirements of welds, acceptable tolerances for welds, etc. This code of practice is very useful for field engineers involved in fabrication of steel girders as it can definitely help in their technical understanding of welding processes and related technical concepts.

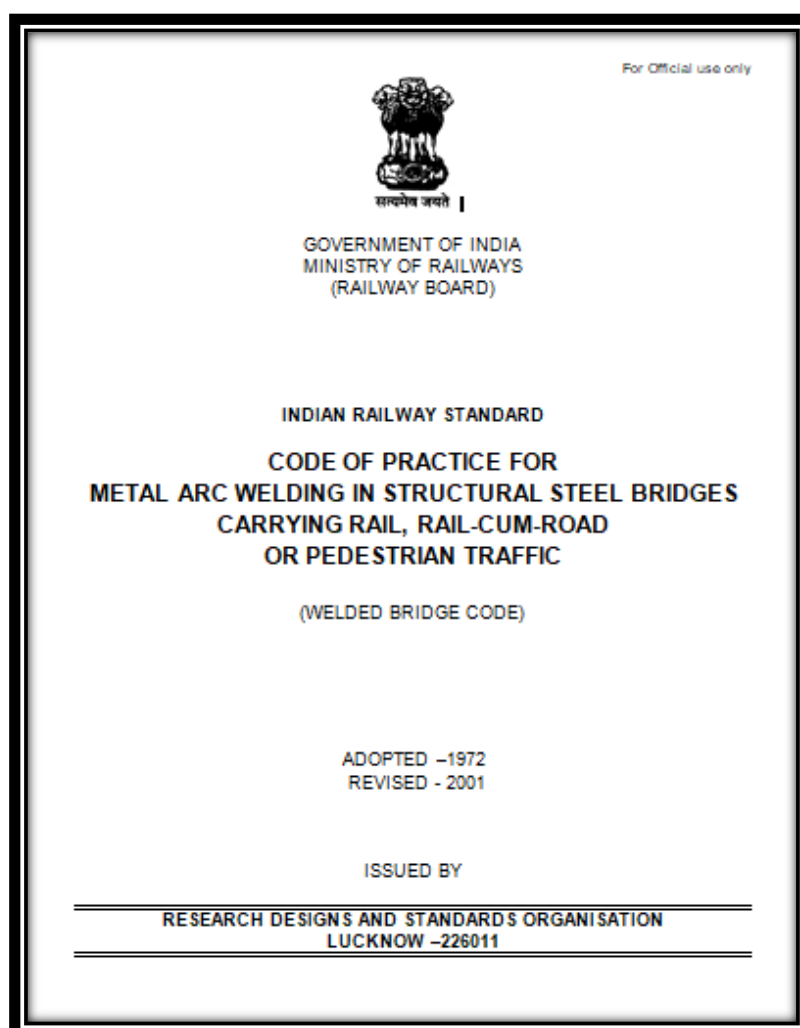

## 6.2 Indian Railway Standard Specification for fabrication and erection of steel girder bridges and locomotive turn-tables (IRS B1- Adopted 1934, revised 2001)

This Specification is intended mainly to cover technical provisions relating to fabrication and erection of steel girder bridges, including supply of the materials through contract or Railway Engineering Workshops. The provisions cover a wide range of technical topics like specifications covering grade and quality of steel, fabrication related technical specifications pertaining to various stages, specification for bolts, nuts, washers etc., instructions related with camber, specifications for oiling, sand blasting, metallising, painting of steel girders, instructions related to weight of steel work for payment, manufacturing tolerances for girders, tolerances and specifications for knuckle and roller bearings, specifications for metallising with sprayed Aluminium for bridge girders and other important instructions/specifications covering fabrication of girders. Apart from this it also contains important proforma required for maintaining records in connection with quality control and inspection.

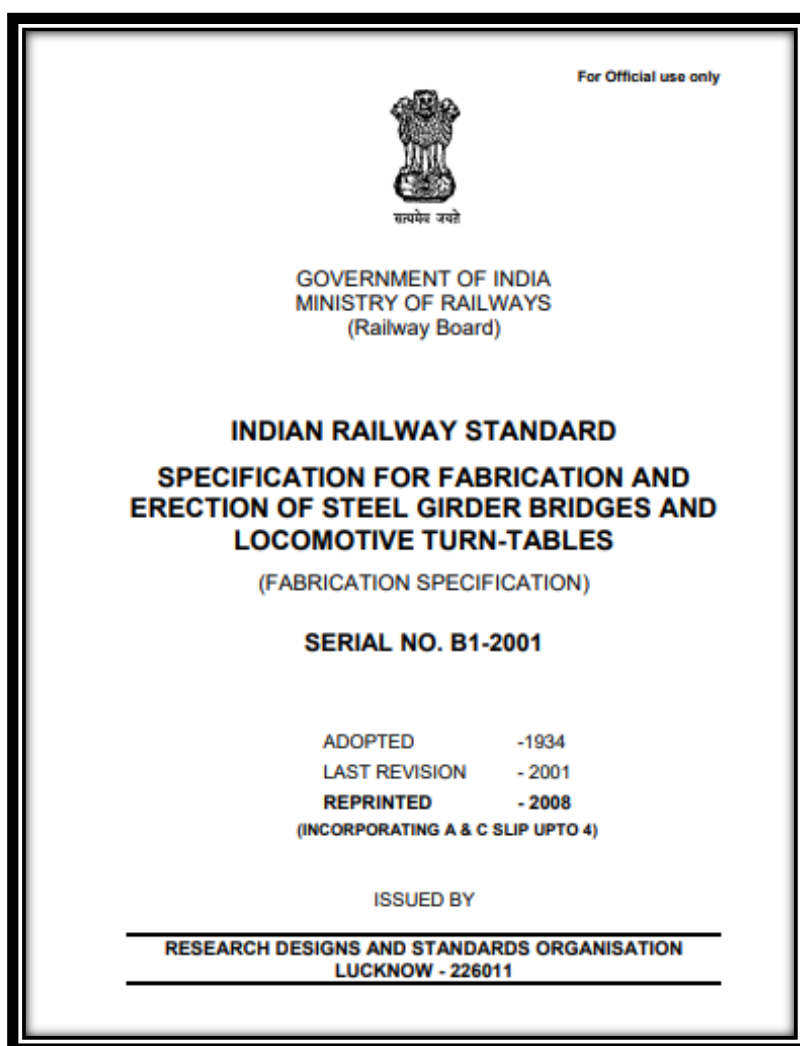



### **6.3 Guidelines on Fabrication of Steel Girders for Construction/Field Engineers BS -110 (R1) (December 2011 Revised 2017)**

The fabrication of steel girder bridges is being done by various Railway Workshops as well as through trade. The fabrication is governed by the provisions of-

- i) Indian Railway Standard specification for fabrication and erection of steel girder bridges and locomotive turn-tables. (B1-2001).
- ii) Indian Railway Standard Code of Practices for metal arc welding for structural steel bridges carrying rail cum road or pedestrian traffic (Adopted 1972 Revised 2001).

The officials associated with fabrication work should have thorough understanding of both the codes i & ii. However, these guidelines have been prepared for helping the field engineers associated with execution of the fabrication work. It has been tried to cover various aspects which require close attention of the field engineers for ensuring quality of the fabrication work. These guidelines are just to facilitate and not to supersede the two codes.

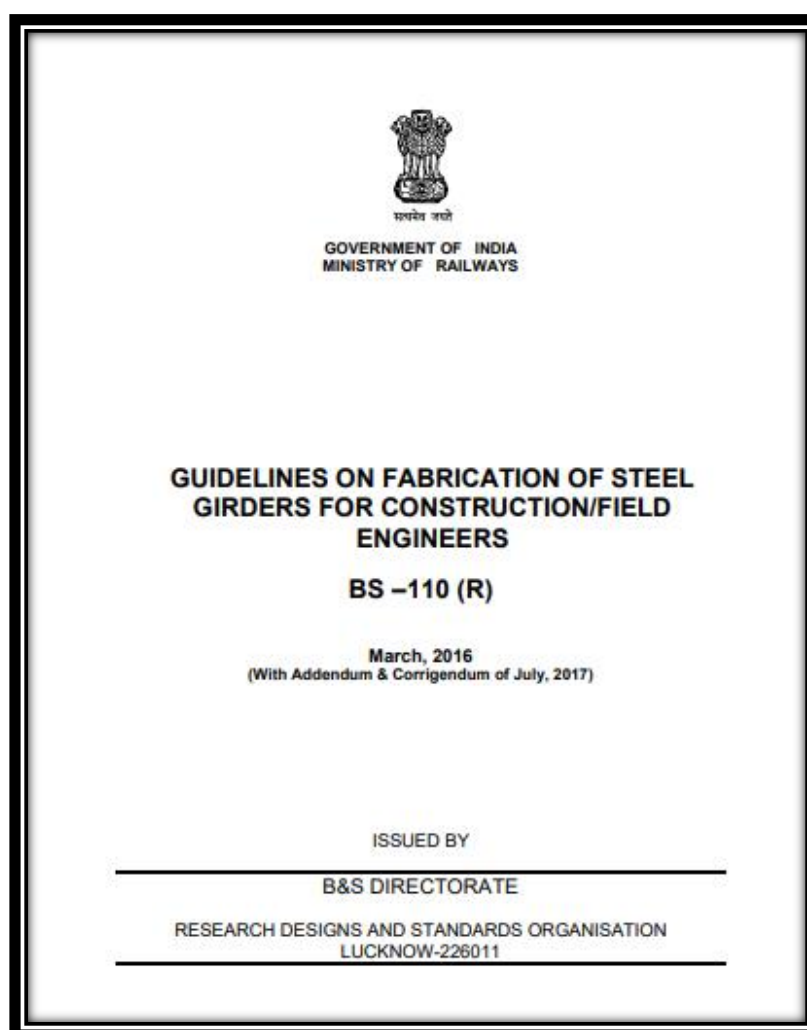

#### 6.4 Guidelines for Composite Construction Including Stud Shear Connectors Report No BS 115 (Revision 1 April 2016)

These Guidelines offer a very good understanding on various technical topics related with composite construction. It broadly covers basic concepts of composite girders, different types of Shear Connectors, Automatic Stud Welding process, Stud Welding Equipments, Quality Assurance Procedure to be adopted for Stud welding and other important aspects related to above topics. Annexure-I of these guidelines also provides proforma for Quality Assurance for inspection of Automatic Stud Welding.

Use of Shear Studs and Automatic Stud Welding are very common these days. A thorough understanding of the associated technical concepts and quality assurance aspect can be found in these guidelines.



## **6.5 Guidelines for Fabrication Inspection of RDSO Standard spans-Composite I-Section Steel Girders for Road Over Bridges (ROBs) (BS-130 June 2021)**

These guidelines are specially made for fabrication inspection of composite I-section steel Road Over Bridge (ROB) girders of RDSO standard spans. The guidelines aim to provide clear understanding of fabrication as-well-as approval related aspects to the field executives. The guidelines also contain standard QAP (Quality Assurance Plan) which can be used to avoid repetitive preparation and subsequent approval in each case. It also contains standard proforma for WPSS (Welding Procedure Specification Sheet) and WPQR (Welding Procedure Qualification Record).

Off late many Railway PSUs like RVNL, DFCCIL, IRCON etc. and many Non-Railway PSUs like NHAI, NHIDCL etc. have started manufacturing steel girders. There was a lack of clarity regarding clear understanding of roles to be performed by Railway and these PSUs at various stages of fabrication. These guidelines contain a schedule for inspection and approval of these girders in all such cases. It is attached as Annexure-II of this guideline.

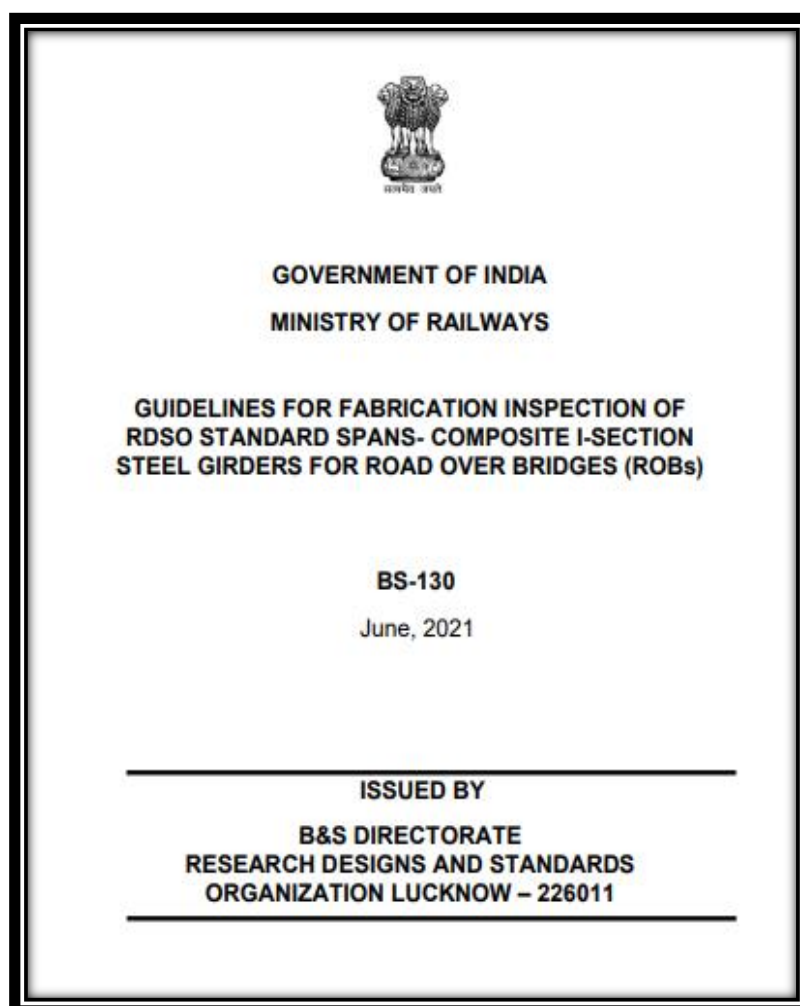

## **6.6 Guidelines for use of High Strength Friction Grip (HSFG) Bolting Assemblies on bridges on Indian Railways (BS-111 Adopted June 2012, 6th Revision May 2019)**

Provision of High Strength Friction Grip (HSFG) bolts has been made mandatory in Bridge Works of Railways. It helps in faster construction and erection of bridges as compared to riveted girders. RDSO had issued guideline no. BS-111 to understand basic functioning and basic technical concepts related with HSFG bolts. This guideline has been revised 6 times to incorporate the latest provisions related to HSFG bolts.

The latest revision of BS-111 (R6) provides for HSFG bolting assemblies aligned with best international practices. Mandatory provision of Direct Tension Indicator (DTI) washer has been made to avoid any subjectivity in achieving full designed tension in these bolts. It also contains provisions for proper tightening procedures, checking tightened bolts, corrosion protection measures etc.

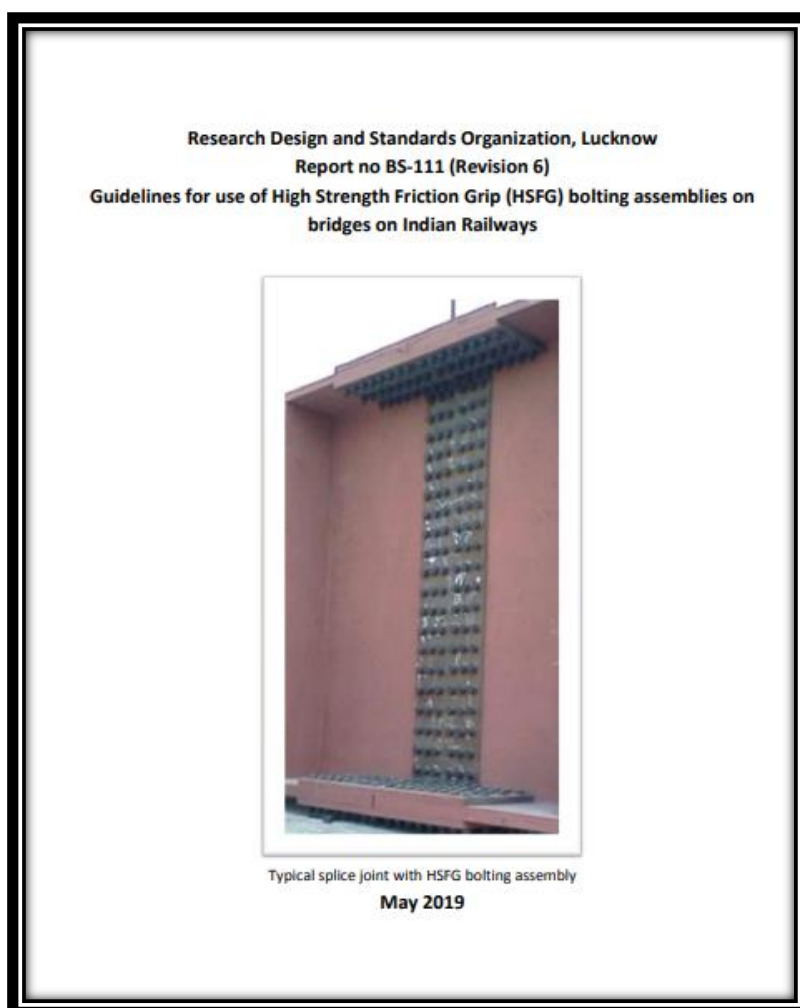

## **Chapter VII**

### **Instructions regarding launching of girders**

This page is left blank intentionally.

## 7.1 Introduction:

**7.1.1** Launching of ROB girders basically involves all the operations involved in assembling, putting the assembled girders in position over pier caps and lowering of girders to their final position over bearings.

**7.1.2** As discussed earlier, ROBs are constructed in lieu of Level Crossings where road traffic is very high. Generally space constraints are there for assembling the full girder, erecting temporary supports and to perform the related operations. Since neither track nor road can be blocked for assembly of girders therefore it becomes very important to follow all possible safety measures while preparing the girder for launching and erecting temporary arrangements for launching. Any mistake can be fatal from human safety point of view. Therefore launching of girders over Railway Tracks is a very challenging and complicated procedure involving many operations which are to be performed with utmost precision so as to ensure full safety of Road users as well as Railway passengers.



Fig 1 Photo: View of Bow String Arch Girder during construction stage (Park Circus station of Eastern Railway)





Fig 2 Photo: View of Bow String Arch Girder from Railway Station during construction stage (Park Circus station of Eastern Railway)

## **7.2 General requirements for launching of ROB girders over railway tracks**

- i. CRS sanctions should be obtained for launching scheme of girder.
- ii. Traffic and power blocks are to be arranged for erection of steel girder over Railway Track.
- iii. Track is to be protected in accordance with relevant clauses of Indian Railways P. Way Manual.
- iv. Pulling/ launching of the girder shall be stopped in case wind speed at site exceeds 15 kmph and it shall be made sure that weather conditions are normal and visibility is clear.



- v. Level & compact the ground as per requirement for assembly of trestle, girder & movement of crane on launching end side.
- vi. Arrange material, crane, cribs/ trestle, 2 pulling winches & 2 restraining winches of sufficient capacity, wire rope of suitable grade etc. for execution of work.
- vii. Safety net shall be provided under the girders while fixing the bracing and shuttering work.
- viii. Clearance from Railway Track to be maintained in accordance with Indian Railway Schedule of Dimensions for Broad Gauge.
- ix. Protect the site of work for any trespass of any living beings.
- x. Ground at the location of trestle pedestal should be compacted to attain safe bearing capacity of soil. Field engineer should certify that SBC of soil is more than foundation pressure at foundation level.
- xi. Launching Track should be laid in correct alignment & level on trestles for longitudinal slewing of girder.
- xii. Speed restriction of 20 kmph is to be imposed before start of work & will be continued up to completion of work.
- xiii. Skid plate surface for skidding arrangement shall be smoothed by lubrication. It shall be ensured by field engineer, that there should be no gaps in skid plate, which should be closed by welding & smoothed by grinding.
- xiv. Before launching of girder, it must be ensured that fabrication of girder and its inspection have been done as per approved QAP (Quality Assurance Plan) & WPSS (Welding Procedure Specification Sheets).
- xv. All steel to steel member will be connected with tack weld to avoid any longitudinal & transverse movement.

- xvi. Pulling arrangement shall be trial tested with actual load well before taking traffic and power block.
- xvii. Fabrication of BSG shall be done after locking the skidding arrangement with suitable method. Locking shall also be done after each stage of pulling to prevent from skidding.
- xviii. The condition of crane shall be strictly observed in the light of Railway Board letter no. 2015/CE-IV/RUB/206 dated 15.02.2015 and other instructions issued from time to time.
- xix. Any activity near or over existing railway track shall be performed under traffic & power block.

### **7.3 Composite Steel Plate Girders:**

#### **7.3.1 Assembly of composite girder leaves at site**

**7.3.1.1 General:** Composite Plate girders are fabricated in convenient lengths to suit transportation and availability of plate lengths. In general, the length is restricted to about 12m to 13m so as to facilitate transport in single lengths.

**7.3.1.2 Erection of composite plate girders:** Normally a composite girder ROB is comprised of multiple composite I-Girder placed at certain spacing. Camber may or may not be provided in these girders. Assembly of pieces of girders transported to site should be done according to the camber provided in the drawing. Girders are erected on a level ground over the platform made up of compacted earth or concrete base. Over this, sleeper or timber pickings at suitable intervals are laid for laying the main members for assembly. After they are laid, levelled and aligned, splicing plates are fixed. Joint holes are partially filled with drifts for bringing them into proper alignment. Provision of HSFG bolts in the splice joints of composite girder should be done in accordance with the procedure given in IRS B1-2000 for this purpose. All girder leaves of composite girder span should be assembled in field according to the approved drawing as mentioned above.

### **7.3.1.3 Choice of a suitable method of girder erection**

Several methods are available for girder erection. The following factors generally influence the suitability of a particular erection method:

- (a) Particulars of Bridge and spans:
  - i) Length, width, height, & weight of girder.
  - ii) Number and type of spans.
  - iii) Height and width of piers and abutments
  - iv) Skew or square span.
- (b) Site conditions:
  - i) Height of gap.
  - ii) Condition of approaches- high or low banks or cuttings.
- (c) Access to site
- (d) Availability of bridging equipment/ launching equipments such as cranes, etc.

**7.3.2 Preliminary arrangements before girder erection:** Site conditions should be carefully studied by visiting the site and noting all the relevant facts before preparing erection schemes. Crosssections of the site and various important levels should be taken. Before embarking on preparation of the scheme, a thorough knowledge of the site conditions as mentioned above should be known.

The following arrangements should be made before actual launching work is started:

- a) Plan the sequence of erection work.
- b) Move the girder materials to the site.
- c) Assembly of girders as per approved drawings
- d) Decision regarding capacity and number of cranes to be deployed according to various site conditions.
- e) Arrange the plant and equipment necessary to carry out the work along with spares.

- f) Preparation of ground for proper working of cranes being used in launching of girders.
- g) Test all the equipment to be used in the erection work.
- h) First Aid and communication arrangement at site.
- i) Arrange for consumable stores.
- j) Arrange for necessary traffic blocks.
- k) Arrange for a proper organisation with Supervisors, Skilled and Unskilled Staff.
- l) Provide facilities for the large labour force that will be employed at site.

**7.3.3 Erection by use of cranes:** This is the most popular method for launching of the composite plate girders ROBs. Composite plate girders can be placed in position with the help of cranes. Tentative sequence of launching operations is given below:

- a) The assembled girders of ROBs, to be brought near the crane as near as possible.
- b) Lifting hooks as per approved launching scheme to be placed in leaves of girder prior to start of traffic block.
- c) Infringements/ obstacles in launching of girder to be removed before traffic block as far as possible e.g. overhead electrical wires to be grounded or lowered during power block.
- d) One or two cranes, as per approved launching scheme is used for lifting the leaf of assembled composite girder at site. Girder lifted by crane is then moved across the railway track and avoiding infringement/ damage to overhead electrical wires. Lifted girder is gradually lowered in position on blocks placed for this purpose.
- e) The placed girder should be properly secured with adjacent girders or with some other suitable arrangement as per approved launching scheme. Securing of girder is one of the most important operations to ensure safety of girder and to avoid its toppling/ falling. Crane should not be removed from the girder unless it is

properly secured.

- f) Girders should be placed in sequence as per the approved launching scheme. If launching of girder is planned from two places then middlemost girder is launched first and thereafter launching of girders from middle to end is done. If launching is done from one place then farthest side girder from crane is launched first and thereafter launching from farthest side girder to nearest side girder is done. However, this might change as per other site condition and sequence of launching should be decided beforehand in approved launching scheme.
- g) After completion of placing, lowering and securing of all girders in position, the cranes should be removed to avoid any infringement to track.
- h) To restore the position of track, overhead electrical wires and any other facility which were removed for launching of girder should be restored before clearing block section for movement of traffic.



(a) Photo: Assembled girders to be brought near the crane



(b) Photo: Lifting of girder with lifting hook



(c) Photo: Lifting of girder



(d) Photo: Crossing of girder across track



(e) Photo: Placing of girder in position



(f) Photo: Placing of all girders in position, secured in place

Fig. 3: Sequence of operations in launching of composite plate girders by crane

## 7.4 Bow String Arch Steel Girders:

### 7.4.1 Girder assembly at site:

- a) It shall be ensured that before starting launching of the BSG all the steel components of the girder are well assembled and welded. No launching is to start without ensuring that all the components are properly welded.



- b) Such assembly of BSG is typically done over temporary arrangements like trestles, longitudinal beams, skidding arrangements and cranes etc.
- c) Normally this activity is planned in such a way that it does not infringe the tracks and generally no traffic/ power blocks are required to complete this activity.



(a) Photo: Erecting temporary arrangements



(b) Photo : Start of assembly of Bottom Beam, Top Chord, Hangers and Cross Girders



(c) Photo: Completing the sequence from one end to the other



(d) Photo: Completing the assembly of Bow String Girder

Fig. 4: Sequence of operations in assembling a typical Bow String Arch girder

#### 7.4.2 Launching:

- a) Most preferred method of launching BSGs is End Launching method with winch machines. In this method BSG is first

assembled over temporary arrangements like trestles and longitudinal beams. Thereafter girder is pulled to its final location with the help of pulling and restraining winches. Thereafter girder is lowered gradually in steps over the bearings.

- b) Bow String Girders are typically suitable for lifting also. Such information is clearly mentioned in the approved drawings. The lifting points are clearly mentioned.
- c) The overhang for which design of BSG has been checked is clearly mentioned in the drawings. Typically, the BSGs are checked for 50% overhang. The launching scheme involving overhang should be planned only after suitably confirming the overhang length for which BSG had been designed and checked.

**7.4.3 Explanatory notes on End Launching Sequence with a typical illustration:**

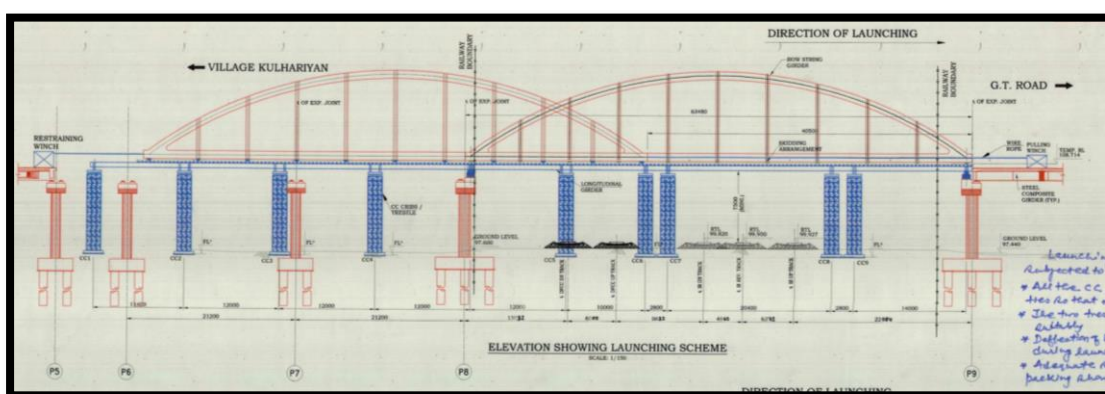

Fig. 5: Typical launching of a Bow String Arch girder

- a) This method is most popular and most widely used for launching of Bow String Girders.
- b) Once the girder is assembled over temporary structures, the girder is ready for the next stage.
- c) In following pages a typical launching and lowering scheme has been shown for understanding and guidance purpose. It does not dictate any instruction or obligation in any sense. Each BSG launching case to have its own approved Temporary Arrangement



Drawings and Launching/ Lowering schemes. This launching scheme needs to be approved by CRS in each case.

- d) One typical case is being discussed in following paragraphs for illustration purpose only. The arrangements shown in blue represent temporary arrangements. The details below have been taken from launching scheme of a BSG over Level crossing no. 67/C at Railway km 638/7-9 between stations Dhanaichha and Durgauti on MGS-GAYA section and at Road km 88191 of Village Road from GT Road to Karmnasha village.

**STAGE - 1**

- Mark the centre line of girder on abutments, Pedestals & on ground.
- Mark the position of trestle on the ground as per approved drawings.
- Cast/place foundation pads for trestles at appropriate locations as per approved structural drawings.
- Erect trestles on foundation pads as per approved structural drawings of trestles. Place steel stools/packing beams on trestles & place temporary longitudinal beam on trestle.

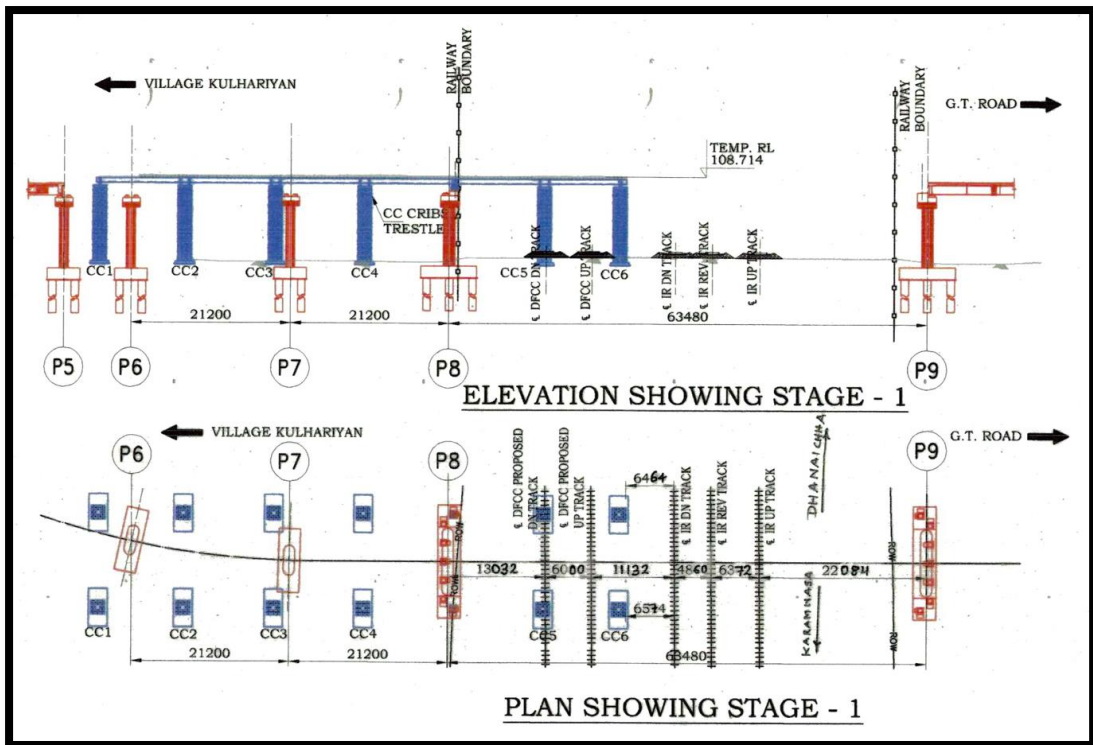

Fig 6: Elevation and Plan of Launching Stage-1

## STAGE - 2

- a) Assemble Bow String Steel Girder on longitudinal beams including X-girders along with the skidding arrangement with suitable thickness of wooden blocks under the bottom chord so that skidding arrangement can properly rest on rails.
- b) Provide hard wood packs & skid arrangement on nodal points at the location of hangers.
- c) Keep the girders in correct plumb & alignment, avoiding infringement to IRSOD (Indian Railways Schedule Of Dimensions) of broad gauge.
- d) Complete the welding work in all respect to assemble the Bow String Steel Girder.
- e) Fix pulling winches & restraining winches at their respective locations.

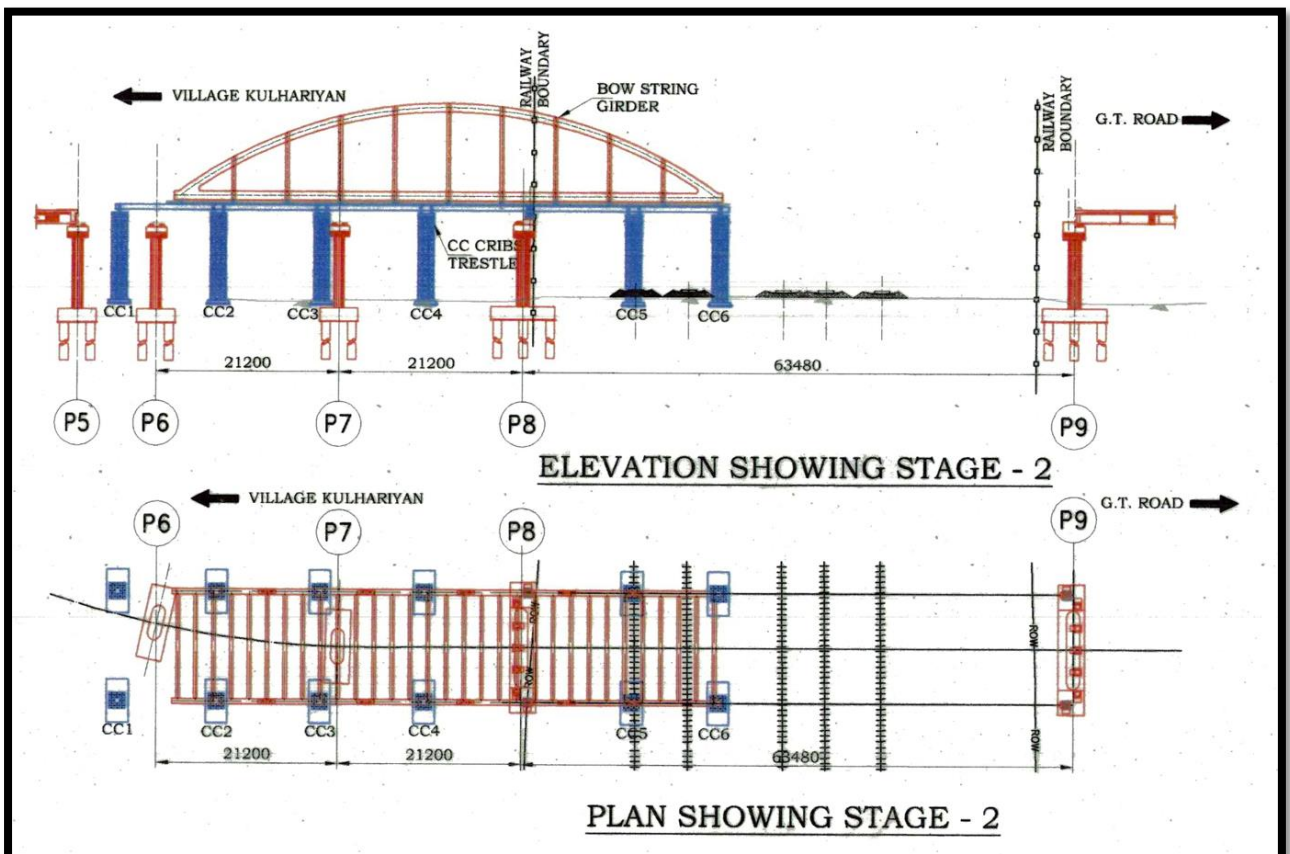

Fig 7: Elevation and Plan of Launching Stage-2

### STAGE-3 (WITH TRAFFIC AND POWER BLOCK):

- a) Erect trestles further, over which the temporary girder is to be laid just above the railway track and place stool/packing beams on them.
- b) Place temporary beam over these Trestles with the help of crane along the direction of road over bridge.
- c) Cross pulling wire from pulling end to another end and secure properly.
- d) Test check the temporary arrangement for its proper functioning & stability.

### STAGE 3A (TESTING):

- a) Before pulling the BSG, it will be ensured that skidding arrangement is under each vertical nodal point of longitudinal bottom chord of BSG.
- b) Then, after ensuring stability of the arrangement pull the Bow String Girder by 3.0m with the help of pulling winches & releasing the restraining winches.

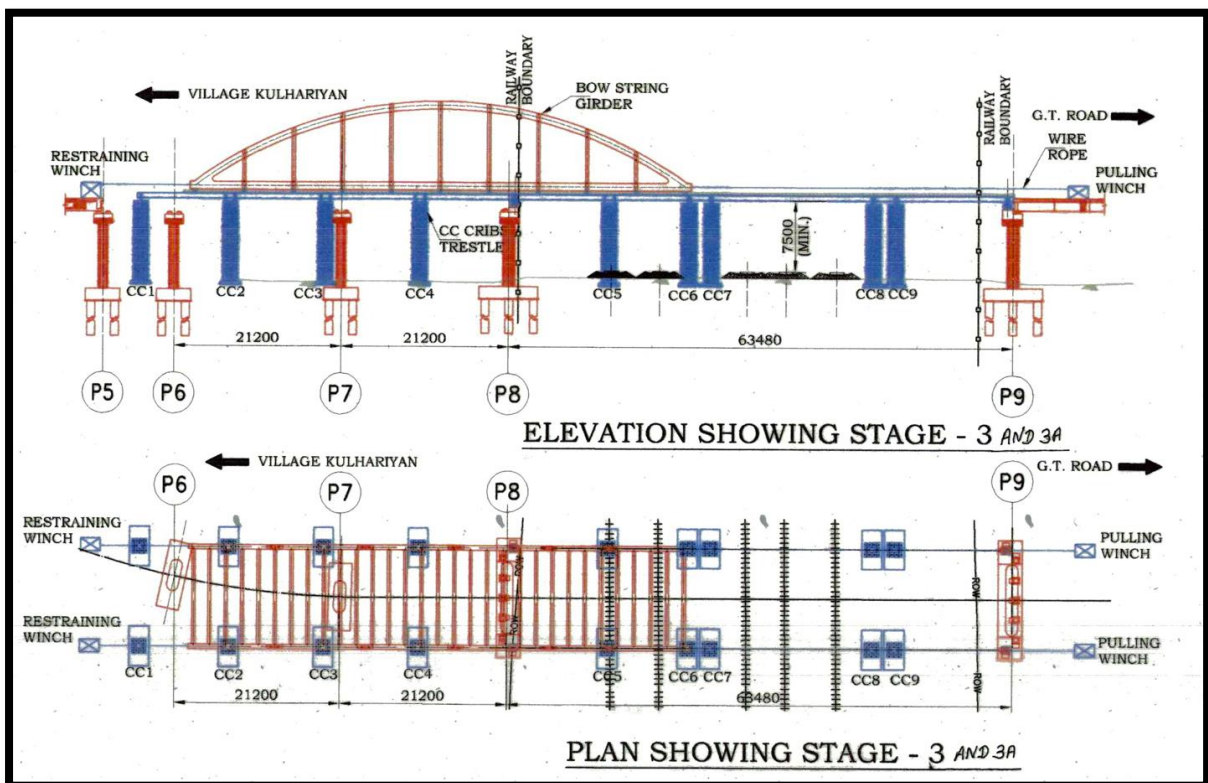

Fig 8: Elevation and Plan of Launching Stage-3, 3A

#### STAGE - 4

- Pull the BSG with the help of pulling winches & releasing the restraining winches up to the last trestle in stages.
- Utmost care needs to be taken to arrest any undesired skidding.
- Proper securing arrangements should be in place at all times during the performance of these operations.

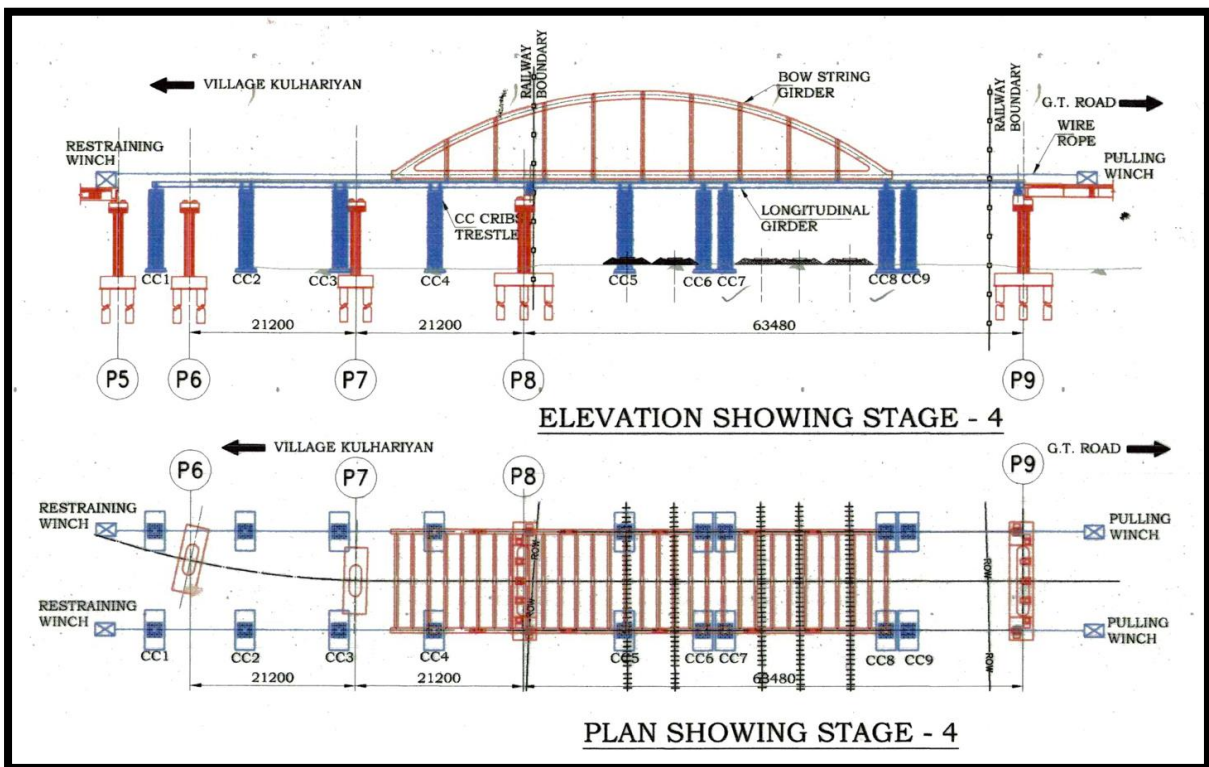

Fig 9: Elevation and Plan of Launching Stage-4

#### STAGE - 5 (FINAL POSITION OVER PIERS)

- Continue pulling the girders with the help of pulling winches and releasing the restraining winches, up to the pier location.
- Presently all the temporary arrangements like longitudinal beams, trestles and CC Cribs etc. are in place.



c) Now the girder is successfully placed at the final location over piers.  
 Now after supporting the girder over piers, next operations related to lowering of girder can be started.

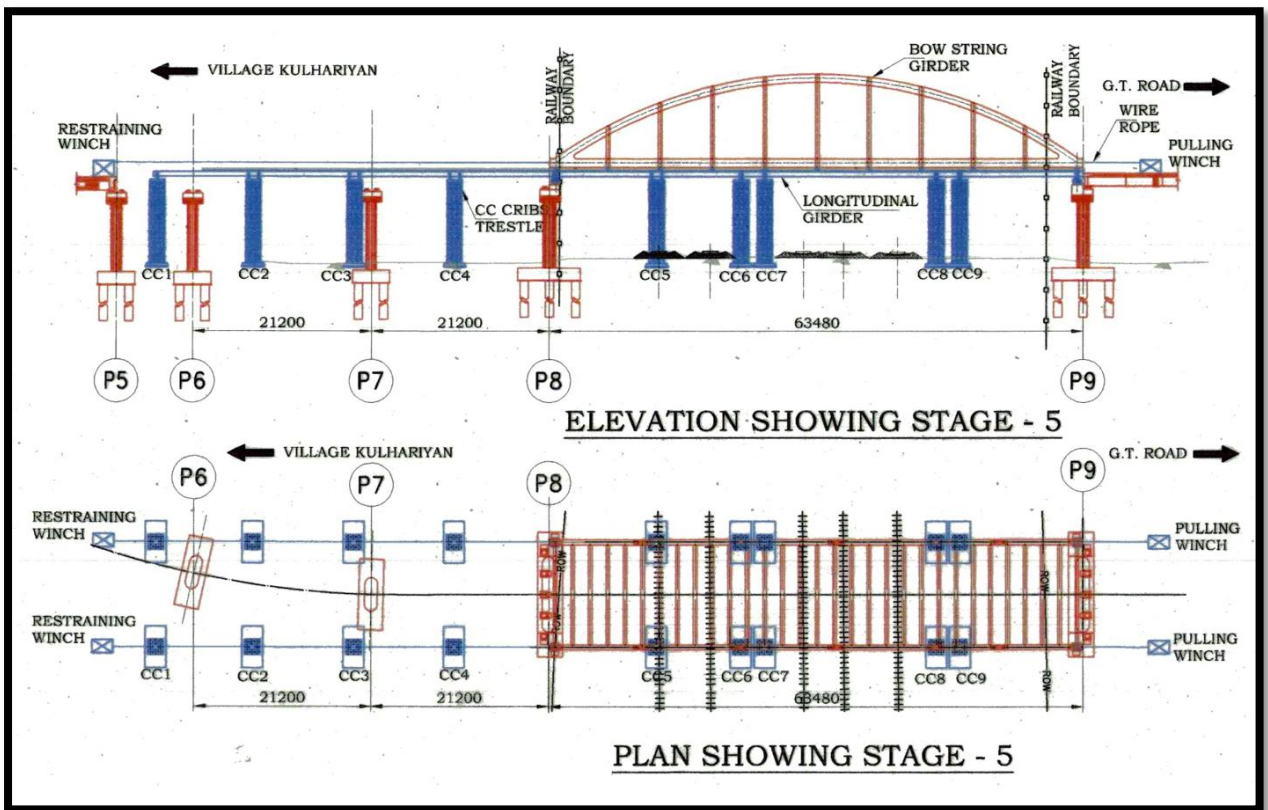

Fig 10: Elevation and Plan of Launching Stage-5

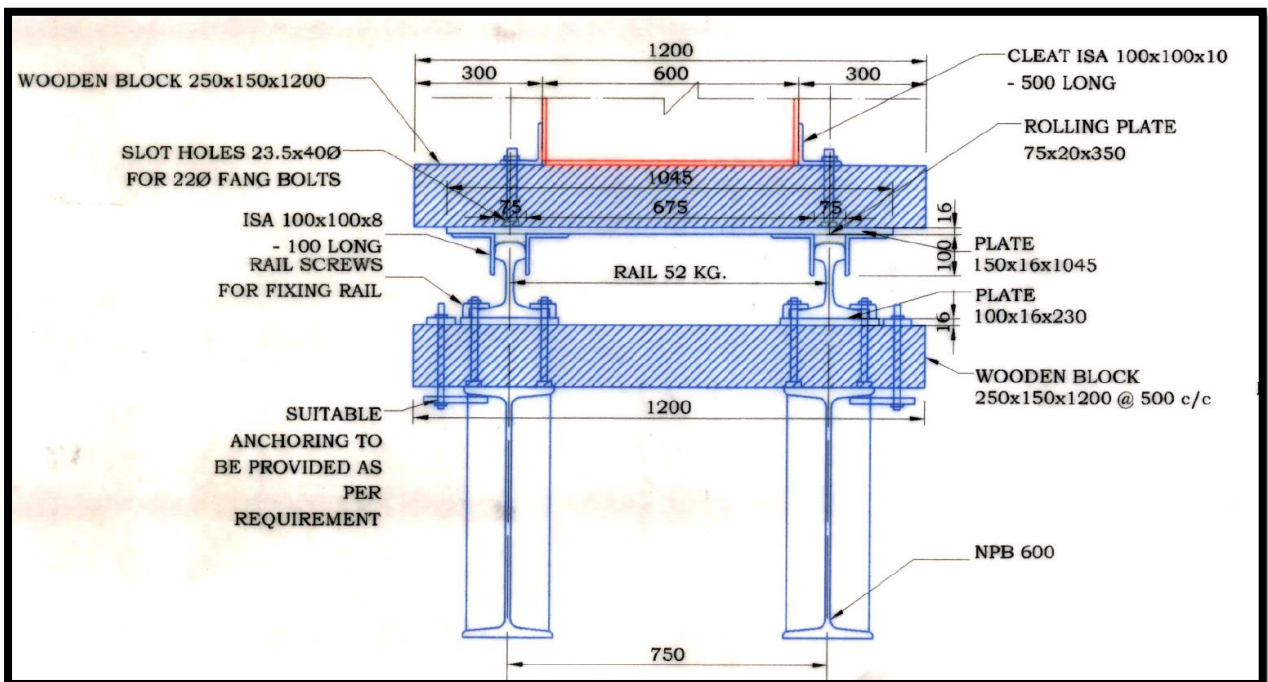

Fig 11: Typical section of Skidding Arrangement

#### 7.4.4 Illustration of launching through photographs:



(a) Photo: Erection of temporary arrangements- Trestles



(b) Photo: Erection of temporary arrangements- Longitudinal Beams



(c) Fixing longitudinal beams and Trestles



(d) Photo: Completing Temporary arrangements for launching



(e) Photo: Fixing Winch and rope assemblies



(f) Photo: Launching of BSG over temporary arrangements





(g) Photo: Bringing BSG to its final location over piers

Fig.12: Photos illustrating various steps involved in launching of Bow String arch Girder (LC no. 67/Cat km. 638/7-9 between stations Dhanaichha and Durgauti in MGS-GAYA section)

**7.4.5 Explanatory notes on Lowering operations with a typical illustration:**

**STAGE - 1**

- a) Currently the girder is longitudinally in its final location.
- b) Presently all the temporary arrangements like longitudinal beams, trestles and CC Cribs etc. are in place.

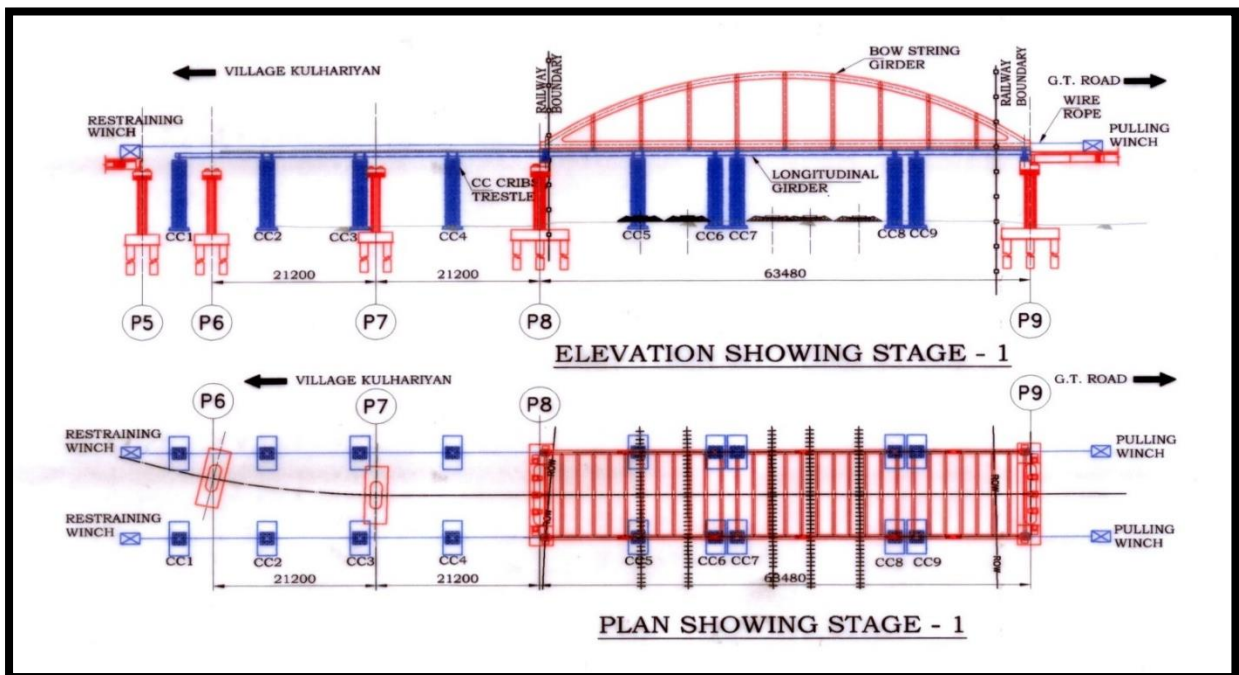

Fig 13: Elevation and Plan of Lowering, Stage-1

## STAGE - 2

- Provide jacks below end cross girders.
- Jacking points are shown in the drawings and stiffener plates are provided inside of these End Cross Girder at these locations to support the point loads of jacks.

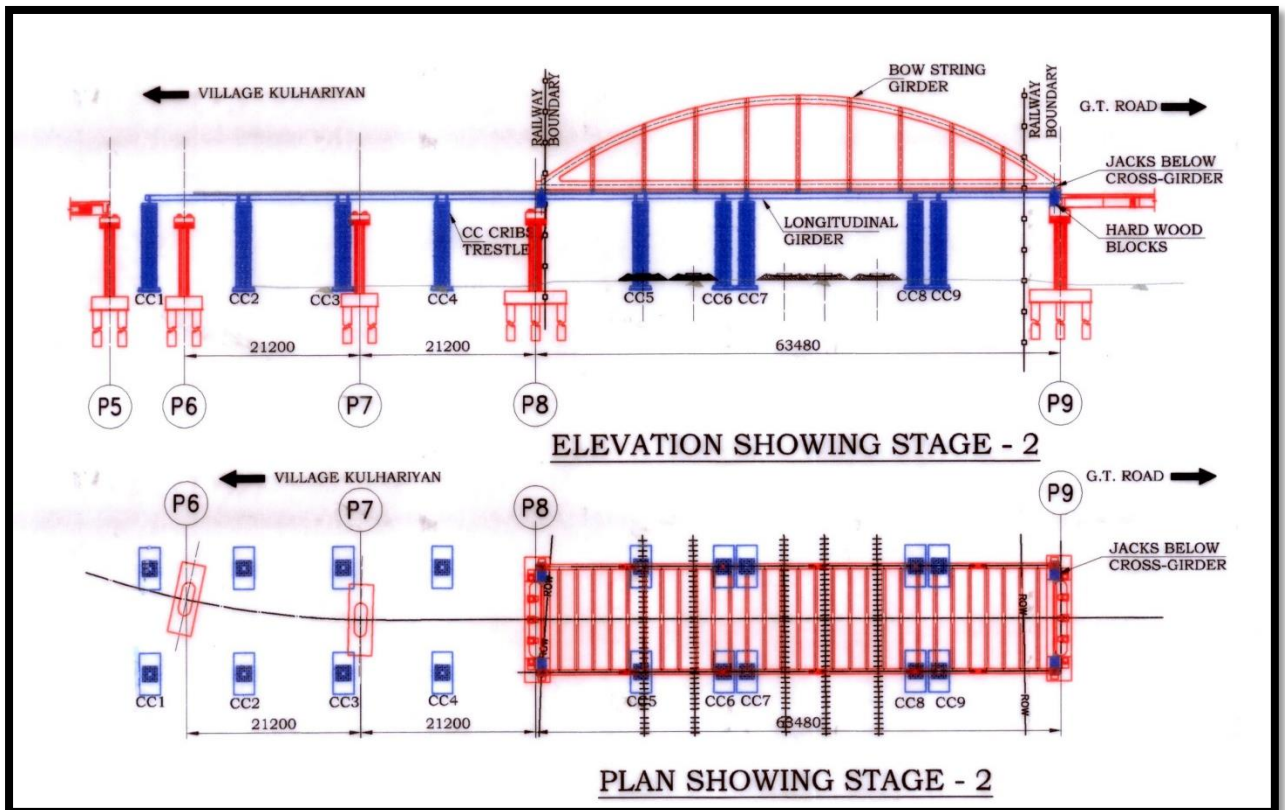

Fig 14: Elevation and Plan of Lowering, Stage-2

## STAGE - 3

- Lift Bow String Girder using jacks below end cross girder.
- Remove temporary beams & rolling arrangement with help of Jacks & Cranes.
- Remove trestle with help of Cranes.
- Provide hard wood packs below bottom chords on piers in sequential manner and equally at all bearing locations.



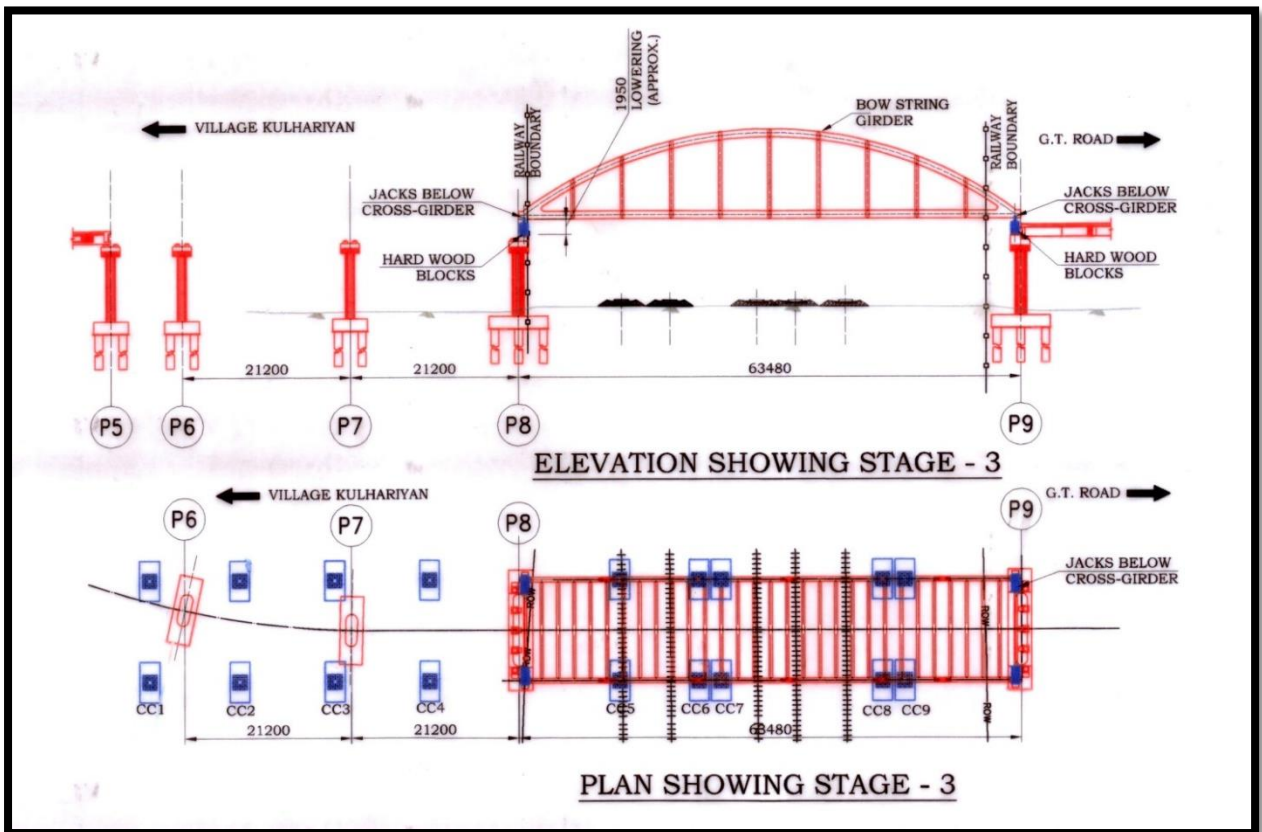

Fig 15: Elevation and Plan of Lowering, Stage-3

#### **STAGE - 4**

- a) Lower the girders with the help of jacks sequentially. The lowering needs to be done in steps say 25mm in one step and then check the level & alignment after each step on all four bearing locations. It will help in arresting the twist.
- b) Fix the bearing & grout the Anchor Bolts of bearing after ascertaining correct position & level of bearing.
- c) Final lowering of BSG on bearings.
- d) Arrange to cast the deck slab as per approved drawings.
- e) Correct alignment & level on bridge as well as in approaches.
- f) Remove all the material provided for launching of girder and clear the site.
- g) The BSG is now successfully placed at in its final location.

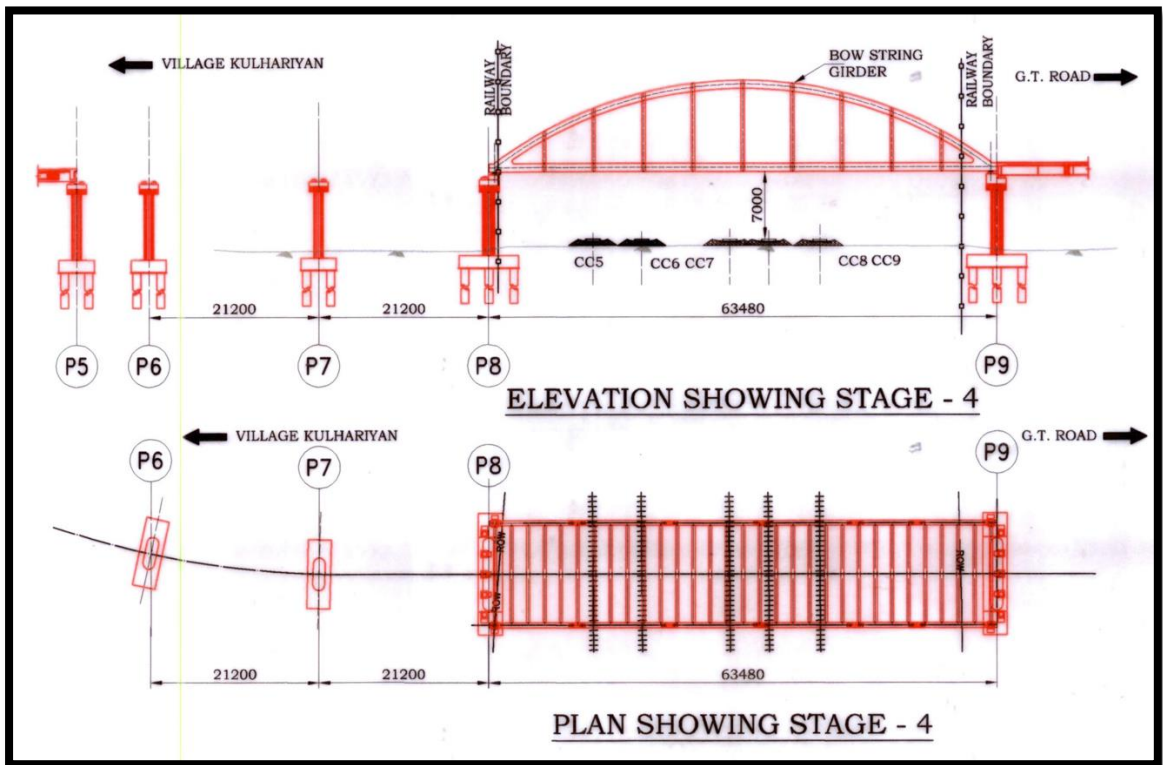

Fig 16: Elevation and Plan of Lowering, Stage-4

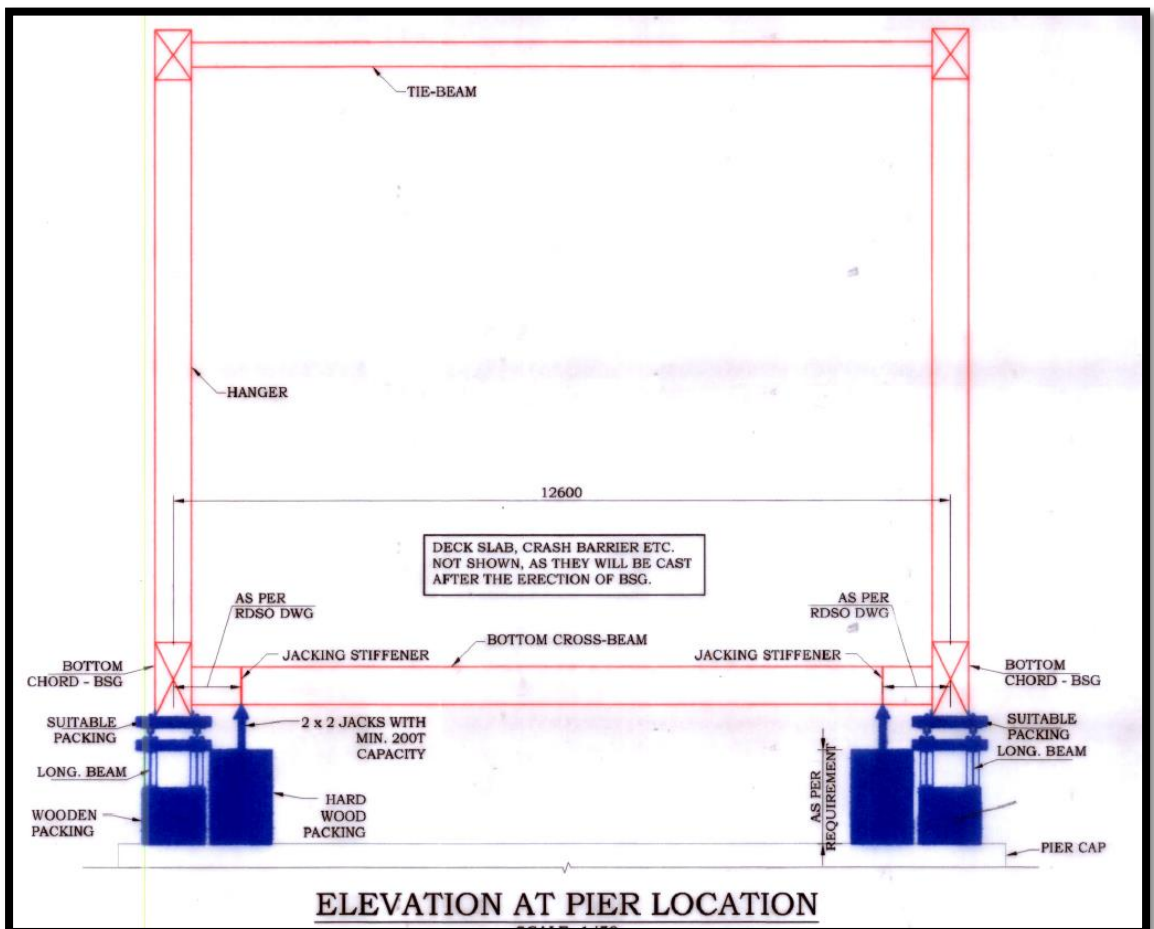

Fig 17: Jacking arrangement at pier location



**7.4.6 Typical Lowering arrangement photographs:**



(a) BSG positioned over piers with temporary arrangements in place



(b) Supporting of BSG over piers and removal of beams



(c) Supporting of BSG over piers and removal of beams continued



(d) Clearing of site after removal of all ground arrangement



(a) Photo: Arrangement of temporary support for lowering



(b) Photo: Jacking arrangement below End Cross Girder

Fig 18: Photos illustrating lowering arrangements of Bow String Arch Girder (LC no. 67/Cat km. 638/7-9 between stations Dhanaichha and Durgauti in MGS-GAYA section)

This page is left blank intentionally.

## **Annexures**

This page is left blank intentionally.

GOVERNMENT OF INDIA  
MINISTRY OF RAILWAYS  
(RAILWAY BOARD)

No. 2015/CE-IV/ROB-RUB/Misc./49

New Delhi dt: 29.10.2019

Principal Chief Engineer,  
All Zonal Railways,

Chief Administrative Officer (Con.),  
All Zonal Railways,

**Sub: Issues related to MoRTH/NHAI.**

**Ref:** This office letter of even number dated 23.07.2018.

On the issue of the length of span of ROB within Railway boundary following decision were taken during meeting held on 23.07.2018 between ME & DG/MoRTH:-

- i. "For ROB being constructed in Railway yard or near year, pier/abutment should be located just out-side / at the railway boundaries to the extent possible.
- ii. At other locations, if future requirement of track is not justified/can be accommodated within 45m, as for as possible road span over track should not exceed 45m.
- iii. In case of dispute between CBE and MoRTH/NHAI, the matter shall be decided by GM of Zonal Railway considering the future requirement of Railway and site feasibility".

Copy of minutes of the meeting under reference is again enclosed. NHAI represented to PED/Bridges that they are facing difficulty in finalization of drawings as per above guidelines.

Zonal Railways are advised to ensure finalization of drawings as per above guidelines. No delays on this account should occur.

DA: As above.

  
29/10/19  
(Subodh Kumar)  
Director CE/B&S-II  
e-mail: [dircebns2@gmail.com](mailto:dircebns2@gmail.com)

**Copy to:** (i) DG/MoRTH for information please.  
(ii) Chairman/NHAI for information please.

This page is left blank intentionally.



**GOVERNMENT OF INDIA  
MINISTRY OF RAILWAYS  
(RAILWAY BOARD)**

सं.: 2017/CE-IV/ROB /164 (Policy)

2022  
दिनांक: 16.02.2021

- 1) General Managers,  
All Zonal Railways
- 2) General Manager (Construction),  
N.F. Railway

**विषय:** Skew angles to be adopted in the Road Over Bridges (ROBs)

1. Demands for design of Road Over Bridges (ROBs) with skew angles are received by Zonal Railways due to site conditions. It may be noted that skew girders are subjected to torsional loads as well as extra bending moments on the obtuse corner. The acute corners are subjected to uplift as a result of the asymmetry of the load due to the skew girders. Larger skew angles are not desirable as capturing the proper behaviour of girder at larger skew angles is very difficult. Providing sufficient torsional restraint is also difficult. Therefore, efforts shall be made to get the square alignment, if possible, or to reduce skew angles to minimum.
2. Clause 105.3.3 of IRC:5-2015 mentions that skew angles in any bridge should preferably not exceed 30°. Hence Zonal Railways should ensure that skew angles in the ROBs should be within 30°.
3. In case it is not possible to keep the skew angle within 30° due to typical site conditions, then following should be followed:
  - (a) For skew angle beyond 30° and up to 45°: Chief Bridge Engineer (CBE) of Zonal Railway is competent authority to approve after considering all relevant site and design factors. Concerning road project executing authority (NHAI, PWD, etc.) should submit proposal with relevant site and design details. CBE may grant approval recording the reasons for the same.
  - (b) For skew angle beyond 45°: In exceptional circumstances if skew angle beyond 45° is required, approval of Railway Board should be taken.

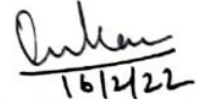
  
16/2/22

**(O. N. Sharma)**  
**Director Civil Engg. (B&S)**

**प्रतिलिपि:**

1. Chairman/NHAI for information.
2. DG/MoRTH for information.
3. PED/Bridge, RDSO for information.
4. PCE, All Zonal Railways for information and necessary action.
5. CAO/Con, All Zonal Railways for information and necessary action.
6. CMD/RVNL, DFCCIL, IRCON, MRVC, KRCL, RITES.

This page is left blank intentionally.

**INNER PAGE OF BACK COVER**

**(BLANK)**

## **"QUALITY POLICY"**

We at RDSO Lucknow are committed to maintain and update transparent standards of services to develop safe, modern and cost effective railway technology complying with statutory and regulatory requirements, through excellence in research, designs and standards by setting quality objectives, commitment to satisfy applicable requirements and continual improvements of the quality management system to cater to growing needs, demand and expectations of passenger and freight traffic on the railways through periodic review of quality management systems to achieve continual improvement and customer appreciation. It is communicated and applied within the organization and making it available to all the relevant interested parties."

**RESEARCH DESIGNS AND STANDARDS ORGANISATION  
MINISTRY OF RAILWAYS,  
MANAK NAGAR, LUCKNOW-226011  
WEBSITE : [WWW.RDSO.INDIANRAILWAYS.GOV.IN](http://WWW.RDSO.INDIANRAILWAYS.GOV.IN)**